

KODIAK[®] RECIRCULATING CHILLERS

TECHNICAL MANUAL

RC006, RC009, RC011, RC022, RC030 and RC045
G03, H03 and J03 Series



Lytron Inc., 55 Dragon Court, Woburn, MA 01801, USA
Tel: +1-781-933-7305 Fax: +1-781-935-4529
www.Lytron.com



© Lytron Inc., 2010

{THIS PAGE IS LEFT BLANK INTENTIONALLY}

TABLE OF CONTENTS

TABLE OF CONTENTS.....	1
REVISION HISTORY.....	3
INTRODUCTION.....	4
SAFETY PRECAUTIONS.....	5
LABELS AND SILKSCREEN MARKING.....	6
PART NUMBER DESCRIPTION	8
SPECIFICATIONS.....	9
PERFORMANCE GRAPHS.....	10
GENERAL INFORMATION	11
CONTROLLER DISPLAY PANEL FUNCTIONS.....	12
REAR PANEL COMPONENTS	13
OPTIONAL SYSTEM FEATURES	14
CONTROLLER OPTIONS	16
INSTALLATION REQUIREMENTS	17
INSTALLATION PROCEDURE.....	18
PRIMING TURBINE AND CENTRIFUGAL PUMPS.....	19
CONNECTING POWER (FOR UNITS WITHOUT HEATER OPTION).....	20
CHILLER OPERATION	21
SYSTEM MAINTENANCE AND SERVICE	24
DRAINING PROCEDURE FOR KODIAK CHILLERS	26
COOLANT MAINTENANCE	27
ERROR CODES.....	28
TROUBLE SHOOTING GUIDE.....	29
KODIAK SPARE PARTS	31
ACCESSORIES FOR THE KODIAK RECIRCULATING CHILLER.....	32
FRONT VIEW.....	33

REAR VIEW (WITH PANEL)	34
TOP VIEW	35
REAR VIEW (OPENED)	36
SIDE VIEW	37
SIDE VIEW (WITH HIGH PRESSURE CUTOUT)	38
CHILLER DIMENSIONS FOR RC011 AND RC022	40
CHILLER DIMENSIONS FOR RC030 AND RC045	41
WIRING DIAGRAM	42
PLUMBING DIAGRAM	42
PLUMBING DIAGRAM	43
REFRIGERATION DIAGRAM	44
HOST INTERFACE DATA LINK	44
HOST INTERFACE DATA LINK	45
LYTRON COOLING SYSTEMS SERVICE POLICY	48
LYTRON KODIAK RECIRCULATING CHILLER STANDARD WARRANTY	50
DECLARATION OF CONFORMITY	51

REVISION HISTORY

REV	ECN / DATE	REASON FOR CHANGE
Y	17284 / 07/08/2010	Updated Declaration of Conformity and safety symbols.

INTRODUCTION

Receiving the New Kodiak® Chiller

Inspect the new chiller immediately upon receiving it. If the unit shows shipping damage, contact the transportation company and file a freight damage claim. Retain all cartons and packing material until the unit is operated and found to be in good condition. The chiller has been fully tested at the Lytron factory with clean water. Although the system has been drained, some residual fluid may remain. This will not hinder the performance of the chiller.

About the Warranty

All units returned for warranty claims must have an RMA (Return Material Authorization) number on the outside of the container. Call Lytron Customer Service at +1-781- 933-7300 for an RMA number. Refer to the end of manual for the chiller warranty. Units should be drained of all fluids and packaged in its original packaging.

Customer Service Support

Lytron is committed to servicing the customer, both during and after the sale. If you have any questions concerning the operation of your unit, contact our Application Engineering Department at +1-781- 933-7300. To facilitate your call, please have the model number and serial number of the unit (located on the rear of the chiller) for the Lytron Applications Engineer.

Service Hotline

Lytron has a 24-hour per day, 7 day per week service hotline to help you with questions on the startup and operation of your Kodiak recirculating chiller. **(Lytron recommends consulting the troubleshooting guide on page 29 before calling the service hotline.)** Lytron service can be reached by dialing +1-781- 933-7300. To facilitate your call please have the model number and serial number (located on rear of the chiller) of the unit for the Lytron Service Technician.















® Kodiak is a registered trademark of Lytron, Inc.

SAFETY PRECAUTIONS

This system is designed to provide fluid cooling only as specified in this manual. If this system is used in a manner other than as specified, the safety protection of the system may be impaired.

Warnings are posted throughout the manual. Read and follow these important instructions. Failure to observe these instructions or use the chiller other than as specified may impair safety protection, void the warranty, and can result in permanent damage to the unit, significant property damage, personal injury, and/or death.

Make sure you read, understand, and follow all instructions and safety precautions listed in this manual before operating your unit. If you have any questions concerning the operation of your unit or the information in this manual, please contact our Applications Engineering Department at +1-781- 933-7300.

-  **Always turn the unit "OFF" and disconnect the power cord from the power source before performing any service, maintenance procedures or before moving the unit.**
-  **Do not operate equipment with damaged power cords.**
-  **A qualified technician should perform Service and repairs.**
-  **If the set point is 10° C (50° F) or below, a freezing point depressant, such as ethylene glycol, is required. This unit is equipped with a low flow switch. This feature will shut the chiller down during a low flow situation to prevent freezing.**
-  **DO NOT USE AUTOMOTIVE ANTI-FREEZE IN THE CHILLER. The rust inhibitors in the automotive type may cause premature failure of the pump seals. Use of automotive anti-freeze in a Lytron chiller will void the warranty.**
-  **Never place the unit in a location where excessive heat, moisture, or corrosive materials are present.**
-  **The unit must be plugged into a properly grounded power source.**
-  **Do not connect the SUPPLY or RETURN fitting to your building water supply or any pressurized source.**
-  **DO NOT USE OR MAINTAIN THE CHILLER OUTDOORS. These units were not designed to withstand outdoor weather conditions.**
-  **Performance of installation, operation, or maintenance procedures other than those described in this manual may result in a hazardous situation and may void the Lytron warranty.**
-  **Transport the unit with care. Sudden jolts or drops can damage the unit.**
-  **Drain the chiller of all water when transporting, shipping or leaving unused for long periods of time. This will prevent freezing and algae build up while idle.**
-  **Observe all warning labels. Never remove warning labels.**
-  **Do not operate damaged or leaking equipment.**
-  **Do not operate the unit without fluid in the reservoir.**

LABELS AND SILKSCREEN MARKING



EXTERNAL CONTACTS
.5 AMPS MAX

FILTER CARTRIDGE HAS
BEEN INSTALLED

RS-232

PUMP PRIMING VALVE →
OPEN TO PRIME - CLOSE TO RUN

RETURN





SUPPLY





 The symbol on this label is intended to alert the user to the presence of important operating and maintenance (servicing) instructions in the literature accompanying the equipment.

 This symbol on this label cautions the user against the risk of electrical shock. This label is mounted near of main voltages of the system.

 External contacts have been installed.

 Lets customer know element has been installed.

 RS232 has been installed.

 Identifies the location of the pump priming valve.

 This silk-screen marking identifies the connection where heated fluid is returned from the user's machine.

 This silk-screen marking identifies the connection where chilled fluid is supplied to the user's machine.

 Positive earth (ground) terminal.

 The markings on this label certifies that the equipment has been certified to the UL standard 61010A-1 and CAN/CSA STD C22.2 No. 1010.1 standards.

 The symbol on this label identifies that the equipment has been certified to regulations of the European Community.

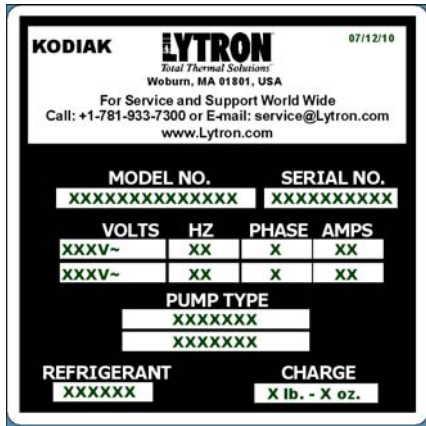

The product ID label identifies the model number, serial number, electrical information, pump type, refrigerant type, charge, and date of manufacture of the product.



The crossed out wheeled bin label requires that the product be disposed of or recycled with the requirements of local law.



The RoHS compliant label indicates that the product complies with the European union restriction of hazardous substances (RoHS) directive.



This label indicates that none of the six hazardous substances are present in the product above the maximum concentration values in its homogeneous form per China RoHS.

有毒有害物质或元素 Hazardous Substances' Name					
铅 (Pb)	汞 (Hg)	镉 (Cd)	六价铬 (Cr(VI))	多溴联苯 (PBB)	多溴二苯醚 (PBDE)
X	O	O	O	O	O

O: 表示该有毒有害物质在该部件所有均质材料中的含量均在SJ/T11363-2006 标准规定的限量要求以下
 X: 表示该有毒有害物质至少在该部件的某一均质材料中的含量超出SJ/T11363-2006 标准规定的限量要求
 •此表所列数据为发布时所能获得的最佳信息
 O: Indicates that this toxic or hazardous substance contained in all of the homogeneous materials for this part is below the limit requirement in SJ/T11363-2006.
 X: Indicates that this toxic or hazardous substance contained in at least one of the homogeneous materials used for this part is above the limit requirement in SJ/T11363-2006.
 •Data listed in the table represents best information available at the time of publication.

This label indicates which of the six hazardous substances are present in the product above the maximum concentration values in its homogeneous form and the environmental protection use period of the product per China RoHS.

PART NUMBER DESCRIPTION

RC006 G03 BB 1 MXXX

Basic Model No.	Electrical Configurations	Pump Options	Controller Configuration	Std. Modification
<p>RC006 - 825 Watts</p> <p>RC009 - 1,050 Watts</p> <p>RC011 - 1,650 Watts</p> <p>RC022 - 2,400 Watts</p> <p>RC030 - 3,450 Watts</p> <p>RC045 - 5,900 Watts</p> <p><i>Note: Cooling capacity and pump flows are rated at 60Hz. For 50Hz power capacity is reduced by 17%.</i></p>	<p>G03 = 115V~/1ph/60Hz</p> <p>H03 = 230V~/1ph/50Hz</p> <p>J03 = 230V~/1ph/60Hz</p>	<p>AA* † = CP-15 Centrifugal Pump</p> <p>BB (CB†) = 1.3 gpm Positive Displacement Pump</p> <p>BC (CC†) = 1.8 gpm Positive Displacement Pump</p> <p>BE (CE†) = 2.3 gpm Positive Displacement Pump</p> <p>BG (CG†) = 4.3 gpm Positive Displacement Pump</p> <p>DA* † = CP-25 Centrifugal Pump</p> <p>EB* (FB†) = 1/4 Hp Turbine Pump</p> <p>EC* (FB†) = 1/6 Hp Turbine Pump</p> <p><i>Notes:</i></p> <p><i>* Water filter and DI cartridge not recommended with Centrifugal & Turbine pumps.</i></p> <p><i>† Indicates high purity compatible pump.</i></p>	<p><u>CONTROLLER PACKAGE #1</u></p> <ol style="list-style-type: none"> 1. Alarm Mute 2. Audible Alarm 3. Auto-Restart 4. Calibration Offset 5. Deg °C / Deg °F Toggle 6. Digital Temperature Display 7. Low Flow Shut-Off Fault <p><u>CONTROLLER PACKAGE #2:</u></p> <ol style="list-style-type: none"> 1. Alarm Mute 2. Audible Alarm 3. Auto-Restart 4. Calibration Offset 5. Deg °C / Deg °F Toggle 6. Digital Pressure Sensing & Display 7. Digital Temperature Display 8. Fault Shut-Off (toggle on/off) 9. Low Flow Shut-Off Fault 10. Low Level Fault 11. Low Temp / High Temp Fault 12. Relay Contacts <p><u>CONTROLLER PACKAGE #3:</u></p> <p>Same as "PKG 2" above with the addition of RS-232 communications.</p>	

NOTE:

Refer to the product ID label on the rear of your chiller for the configuration you have purchased. The table above refers to Lytron's standard product offering for the Kodiak product line.

SPECIFICATIONS¹

	RC006	RC009	RC011	RC022	RC030	RC045
Thermal Capacity ²	60Hz 50Hz	60Hz 50Hz	60Hz 50Hz	60Hz 50Hz	60Hz 50Hz	60Hz 50Hz
Watts	825 685	1,050 875	1,650 1,400	2,400 2,150	3,450 2,950	5,900 4,950
BTU/hr	2,800 2,330	3,585 2,988	5,780 4,760	8,755 7,310	12,070 10,030	20,230 16,830
115V~ 60Hz 1ph	G03	G03	G03	N/A	N/A	N/A
230V~ 50Hz 1ph	H03	H03	H03	H03	H03	H03
230V~ 60Hz 1ph	NA	J03	J03	J03	J03	J03
Full Load Amps ³						
G03	9.9 A	12.2 A	14.3 A	---	---	---
J03	---	5.8 A	7.4 A	10.0 A	14.5 A	19.6 A
H03	4.5 A	5.3 A	6.3 A	9.5 A	13.7 A	17.2 A
Compressor Size	¼ Hp	1/3 Hp	½ Hp	¾ Hp	1 Hp	1 ½ Hp
Refrigerant Type	R134A	R134A	R134A	R134A	R134A	R134A
Temperature Stability	± 0.2°F (0.1°C)	± 0.2°F (0.1°C)	± 0.2°F (0.1°C)	± 0.2°F (0.1°C)	± 0.2°F (0.1°C)	± 0.2°F (0.1°C)
Operating Environment	50°F to 95°F (10°C to 35°C)	50°F to 95°F (10°C to 35°C)	50°F to 95°F (10°C to 35°C)	50°F to 95°F (10°C to 35°C)	50°F to 95°F (10°C to 35°C)	50°F to 95°F (10°C to 35°C)
Coolant Temperature Range ⁴	41°F to 95°F (5°C to 35°C)	41°F to 95°F (5°C to 35°C)	41°F to 95°F (5°C to 35°C)	41°F to 95°F (5°C to 35°C)	41°F to 95°F (5°C to 35°C)	41°F to 95°F (5°C to 35°C)
Reservoir Capacity	1 gal (3.8 l)	1 gal (3.8 l)	2 gal (7.6 l)	2 gal (7.6 l)	6 gal (22.6 l)	6 gal (22.6 l)
Dimensions ⁵						
Width	12.5" (318)	12.5" (318)	14.8" (376)	14.8" (376)	21.4" (543)	21.4" (543)
Depth	19.0" (483)	19.0" (483)	24.5" (622)	24.5" (622)	27.8" (705)	27.8" (705)
Height	22.0" (559)	22.0" (559)	26.5" (673)	26.5" (673)	31.0" (787)	31.0" (787)
Connection	½" FNPT	½" FNPT	½" FNPT	½" FNPT	½" FNPT	½" FNPT
Weight	97 lbs (44 kg)	100 lbs (45 kg)	122 lbs (55 kg)	166 lbs (75 kg)	260 lbs (118 kg)	270 lbs (123 kg)
Process Coolant Delivery Pressure	Factory preset to 90 psig max (for PD and turbine pumps only)					

¹ Specifications are subject to change.

² Capacity is for 20°C delivery water at a 20°C ambient.

³ Full load amperage for air -cooled models with standard pumps without the optional heater. Standard pumps are the BB for the RC006, RC009, RC011, RC022 and BG for the RC030 and RC045. Contact Lytron for current draw of other models.

⁴ Chiller will shut down when coolant temperature reaches 10°C above the coolant temperature range.

⁵ Dimensions do not include filters or external valves.

PERFORMANCE GRAPHS

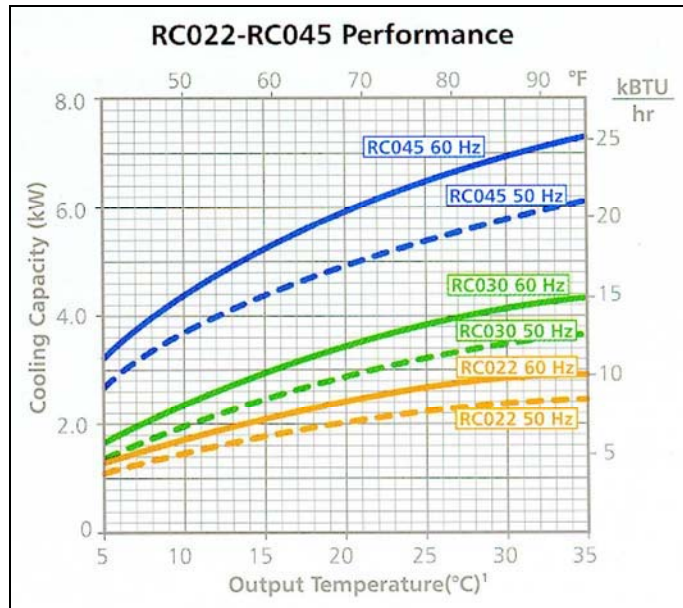
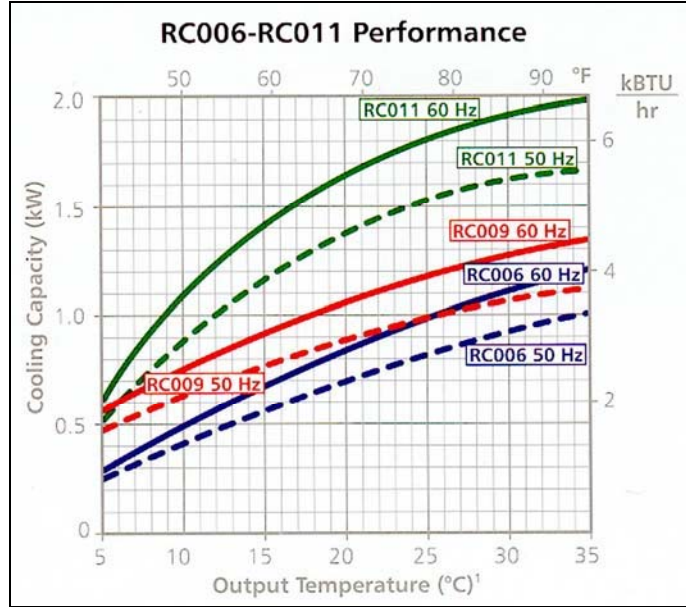

¹ Temperature represents output temperature of water assuming 20°C ambient air conditions. Performance subject to change due to variations such as: fluid type or operating conditions.

GENERAL INFORMATION

Chiller System Description

Your chiller consists of a refrigeration system, a coolant loop, associated controls and plumbing. The pump draws coolant from the internal reservoir and pumps it out to cool the process equipment, and then the coolant flows back to the chiller. The fluid then flows through the evaporator, where the heat is removed, and then back to the reservoir.

Coolant Loop

Kodiak chillers are designed to operate with continuous coolant flow through a closed loop. This loop contains the system pump, temperature sensor, reservoir, internal and external plumbing lines and fittings, and the external heat load. The external plumbing and the heat loads are provided by the end user and are generally unique to the user's process or location.

Refrigeration System and Hot Gas Bypass

The chiller uses a standard refrigeration system to keep the coolant at the process temperature set point. The compressor compresses the refrigerant vapor. The vapor then passes through the condenser where it is cooled and turns to a liquid. The refrigerant then passes through the evaporator. The coolant also flows into the evaporator, through passages separated by thin layers of metal from the refrigerant. The refrigerant evaporates, drawing heat from the coolant. The refrigerant vapor returns to the compressor and continues the cycle.

Many refrigeration systems, such as those used in household refrigerators, control the temperature by turning the compressor on and off. This is a simple, inexpensive method of controlling the cooling, but its temperature control is not precise and the frequent on-off cycles causes wear on the compressor motor.







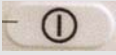

Lytron's recirculating chillers use a better method for controlling the cooling rate: a hot-gas bypass system. This employs a liquid line solenoid valve and a hot-gas bypass valve to meter the refrigerant flow through the evaporator when cooling is needed. When the coolant reaches its set point temperature, the liquid line solenoid valve closes, causing the hot-gas bypass valve to open. The hot-gas valve lets hot gas from the compressor discharge into the evaporator, adjusting the temperature in the evaporator to maintain the correct coolant temperature. When refrigeration is needed the liquid line solenoid valve opens, the hot-gas valve closes and the cycle starts again.

This hot gas bypass control method provides precise temperature control. It also minimizes wear on the compressor motor, since the compressor runs continuously and does not experience the stress of repeated cycling.

CONTROLLER DISPLAY PANEL FUNCTIONS



Controller Display

Key	Operation
	Turn on/off chiller
	Displays Pressure briefly
 "UP" +  "DOWN" + 	Enter menu (press simultaneously and hold for 3 seconds and release)
	Push to display or change set point
"UP" arrow 	Increase set point temperature
"DOWN" arrow 	Decrease set point temperature
	Alarm Sound disabled or Muted (alarm will stay muted until error is corrected, then resets)

DESCRIPTION OF INDICATORS

Temperature Set Point	Displays coolant temperature or set point in °C or °F.
Pressure Display	Displays outputs pump pressure in PSI/bar digitally for a few seconds.
Cooling Indicator	Solenoid valve is open and chiller is cooling the process fluid when this light is illuminated.
Low Flow Indicator	Indicates that the minimum flow requirement of the chiller is not being satisfied.
Alarm Indicator	Illuminates to indicate an alarm fault condition.
Low-Level Indicator	Illuminates to indicate a low fluid level in the tank.
Over Temperature Indicator	Illuminates to indicate water temperature is above high temperature alarm set point.
Low Temperature Indicator	Illuminates to indicate water temperature is below low temperature alarm set point.

REAR PANEL COMPONENTS

(Reference Spare Parts List in this manual)

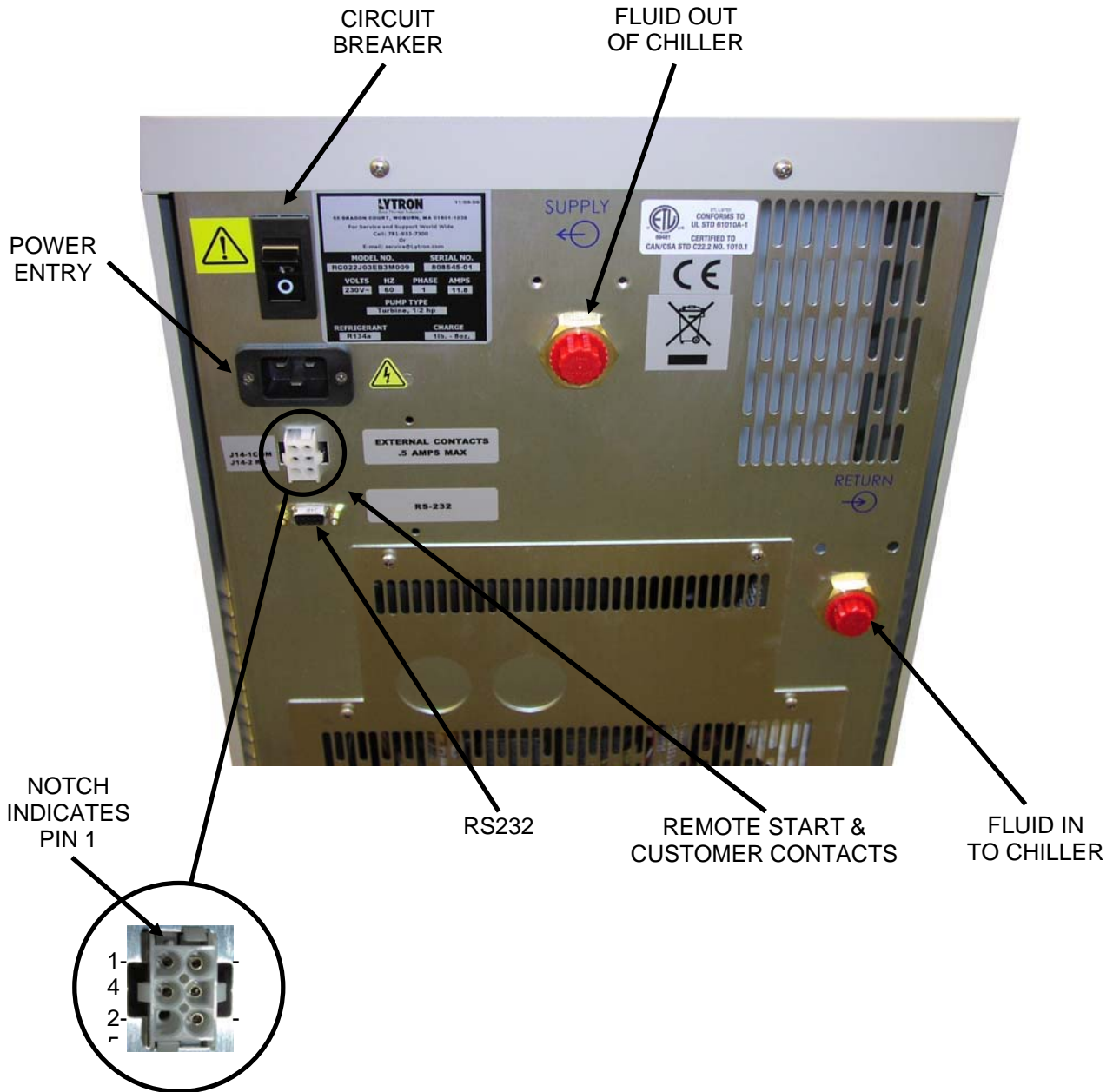

OPTIONAL SYSTEM FEATURES

Coolant Water Filter

The factory installed water filter removes particulate from the coolant water. The water filter is not recommended with centrifugal pumps or turbine pumps. For replacement filters, call Lytron's Customer Service at 781-933-7300.

Deionization Package

The Deionization Package consists of a factory-installed deionization cartridge. The deionization cartridge requires replacement only when the mixed bed is depleted. For replacement cartridges, Call Lytron's Customer Service at 781-933-7300. This package is offered for deionized water applications where the resistance of the water does not exceed 1 Mega-ohm-cm. The deionization package is not recommended with centrifugal pumps.

External Customer Contacts

This option will send a signal indicating there is a problem with the chiller. It can be wired to open on fault or close on fault. This connector is located on the rear left of the system. Pin 5 is the common, Pin 6 closes on fault, and pin 4 opens on fault. The mating connector is Amp part number 350715-1, and the pins for the connector are Amp part number 350547-1. These contacts are rated for 250 V, ½ amp maximum.

External Manually Adjustable Flow Valve

This option allows the flow rate to the equipment to be controlled with a globe valve. Opening the valve allows the flow to bypass from the supply to the return. By adjusting the valve a precise flow rate can be set. To be sure the process equipment is receiving the appropriate flow install a flow meter at the outlet from the process equipment.

External Pressure Relief Valve

This option is for applications with a maximum allowable pressure. It can also be used where flow to the equipment being cooled needs to be shut off without stopping the chiller. In this case the pressure relief valve will open and allow the flow to bypass from the supply to the return. The standard valve has an adjustment range from 50 psi to 100 psi.

Fault Chiller Shut-off

This option will shut the chiller off in the event that there is an alarm condition. It will turn off the power to the pump and compressor and give an error signal on the front panel of the chiller. To reset the system after a fault the main power must be turned off at the circuit breaker.

Heater Package RC011, RC022, RC030 and RC045

The heater package is for applications requiring coolant temperature well above ambient temperature. This package is a single set point type. The heater is activated when the water temperature is 3°F below set point. The heater option is not intended to provide tight temperature control, but to bring coolant temperature up to an application's requirement faster than the refrigeration cycle (hot gas bypass).

High Purity Plumbing

This option is intended for use with deionized water. Only stainless steel and/or plastic components and a nickel-brazed heat exchanger come in contact with the coolant. This option must be specified before the chiller is purchased. It cannot be upgraded in the field.

Remote Start

This option allows the Kodiak chiller to be started or stopped through a computer or a relay. The chiller can be run using a normally open circuit or normally closed. (Look under the section labeled Chiller Operation for more details) R.S. contacts are located on the rear left of the chiller shown previously. It is a six-pin connector with pins 1 and 2 controlling R.S. The mating connector is an Amp 350715-1 plastic housing. The pins are Amp 350547-1. The controlling relay should have SPDT type contacts rated for low current less than or equal to 5VDC at 0.1 milliamp.

RS-232 Serial Port Communication

This option allows control of the chiller via a standard 9 pin serial port connected to a computer. Lytron software is available that simulates the front control panel and all its functions. Alternatively, software can be created to interface with the system described in the section labeled Host Interface Data Link.

Water Cooled Condenser RC011, RC022, RC030 and RC045

This feature replaces the standard condenser and fan with a water-cooled condenser. This requires cooling water to be supplied to the chiller at 75°F (25°C). The facility water pressure must be less than 100 psi. Minimum flow rates are as follows:

Model	Flow Rate (min)
RC011	1.4 gpm
RC022	1.4 gpm
RC030	1.9 gpm
RC045	3.4 gpm

CONTROLLER OPTIONS

CONTROLLER PACKAGES (1, 2, 3) FOR KODIAK[®] CHILLERS

CONTROL PACKAGE #1:

1. Auto-Restart
2. Calibration Offset
3. Deg °C / Deg °F Toggle
4. Digital Temperature Display
5. Low Flow Fault Chiller Shut-Off

STANDARD OPTIONS FOR CONTROLLER PACKAGE #2:

1. Alarm Mute
2. Audible Alarm
3. Auto-Restart
4. Calibration Offset
5. Deg °C / Deg °F Toggle
6. Digital Pressure Sensing & Display
7. Digital Temperature Display
8. Fault Shut-Off (toggle on/off)
9. Low Flow Fault Chiller Shut-Off
10. Low Level Fault
11. Low Temp / High Temp Fault
12. Relay Contacts

STANDARD OPTIONS FOR CONTROLLER PACKAGE #3:

This option has the same features as Package 2 with the addition of:

- RS-232 Serial Port Communications

INSTALLATION REQUIREMENTS

Coolant Requirements

- Lytron recommends using filtered clean water above 10°C/50°F as coolant.
- **NOTICE** If the set point is 10°C/50°F or below, a freezing point depressant, such as ethylene glycol, is required. This unit is equipped with a low flow switch. This feature will shut the chiller down during a low flow situation to prevent freezing.
- **NOTICE** Do not use automotive anti-freeze in the chiller. The rust inhibitors in the automotive type may cause premature failure of the pump seals. Use of automotive anti-freeze in a Lytron chiller will void the warranty.
- Avoid using water with a high mineral content.
- If the coolant is exposed to sunlight add an algaecide to control organic growth in lines.

Electrical Requirements (for units without heater option)

Refer to the Specification section and to the product ID label on the rear of the chiller for the specific electrical requirements of your unit. The chiller power module is configured with a standard international IEC320/C20 inlet. To safely operate the chiller, use an SJT cord set with an IEC 320/C19 receptacle and an inlet plug that is compatible to the local power grid and the power requirements of the chiller. All Kodiak chillers should use SJT 3 conductor 12 AWG minimum power cord.

Selecting Chiller Location

NOTICE Do not operate or store Kodiak chillers outside. These systems are not intended for outdoor use.

To minimize the heat gain and pressure drop through the connecting hoses, the chiller unit should be located as close as possible to the heat load (user equipment). This is more important for units with centrifugal pumps as they are not capable of high head pressures. Coolant lines are best run at or near the same level as the cooling system. Once the chiller is in position lock the casters.

Airflow is critical to optimize performance of the chiller. The front and one side or the back of the unit **MUST** be kept clear and unobstructed. The remaining two sides or back must have minimum clearance of 18" (456 mm). The top clearance must be at least 6" (152 mm). Ensure that the hot air exiting the chiller does not recirculate into the inlet openings. The front of the unit must have a free supply of ambient-temperature air.

Before moving the chiller cap all ports to prevent any coolant leakage. Unlock the casters and move to new location. Once in the new location lock the casters. To prevent freezing during storage drain water if the chiller is located in an area below 10°C (50°F).

INSTALLATION PROCEDURE

Selecting and Locating Hoses

- The coolant ports are located on the rear of the system and are labeled as previously shown on page 13.
- To minimize the pressure loss in the coolant lines, use the largest practical diameter tubing. If substantial lengths of cooling lines are required, they should be pre-filled with coolant before connecting them to the chiller.
- To minimize heat gain, all lines should be as short as possible. Keep them away from heat sources such as radiators and hot water pipes. Lines that cannot be routed away from heat sources should be protected with thermal insulation, preferably at least 1/2" (12.7mm) thick.
- Flexible tubing should be of heavy wall or reinforced construction. All tubing should be rated to withstand 125 psig (9 bar) at 86°F (30°C). Make sure all tubing connections are secured and leak-tight. Also, whenever possible use opaque lines to prevent algae growth during prolonged non-operating periods.

Connecting Plumbing

To connect the fluid lines to the chiller and user equipment follow these steps:

1. Remove the plastic caps covering the supply and return ports on the rear panel of the unit.
2. Attach coolant lines to the supply and return ports on the rear panel. Fittings should either be brass, stainless steel or nylon. **NOTICE** Never use steel or cast iron fittings, as the corrosion will damage the chiller. For chillers with de-ionization cartridges or high purity plumbing Lytron recommends the use of either stainless steel or nylon fittings. The supply port provides chilled coolant to the user's equipment. The return port connects to the outlet of the user's equipment.
3. Check that fittings are tight to prevent leaks.
4. Remove water filler cover on top of the unit to access the reservoir.
5. Fill the reservoir. Use the reservoir sight tube on the front of the unit to see the coolant level in the tank during filling. Be sure to allow for the volume of coolant needed to fill the cooling lines between the chiller and the equipment, if they were not filled with coolant before installation.
6. If the system is a water-cooled chiller, connect facility water to connections labeled "City Water In" and "City Water Out". Minimum flow rate of facility water is shown on page 15. Facility water flow must be started before chiller is turned on.

PRIMING TURBINE AND CENTRIFUGAL PUMPS

NOTICE Running centrifugal and turbine pumps dry for even a few seconds can permanently damage the pump. This style of pump must be “primed” prior to operation.

Pump priming must be performed under the following conditions:

- a. At initial start-up.
 - b. The system is drained of its fluid.
 - c. A new pump is installed.
- Centrifugal and turbine pumps are classified as non-self priming pumps. This means that the pump will not displace the air inside the pump housing, which prevents fluid from being drawn in. Each must be “primed” prior to operation. “Priming” simply means to manually introduce fluid into the pump housing prior to operation.
 - In a typical chiller installation, the flow of fluid through the pump suction hose into the pump is prevented by the presence of trapped air. Without a way for the air to escape, the fluid has no way of entering the pump housing. The following are recommended procedures to prime a turbine or centrifugal pump.



a. Valve in open position



b. Valve in closed position

1. **Units equipped with priming valve.** – The priming valve circuit is located between the pump discharge plumbing line and the top of the tank. There is a valve labeled “pump priming valve” located in this line. To prime the pump simply open this valve prior to starting the chiller (photo a). Start the chiller. After flow is observed returning to the tank, close the priming valve (photo b).
2. **Units that do not have a priming valve.** – To prime pumps that do not have a priming valve, disconnect the supply line from the rear of the chiller. Allow time for the fluid to gravity feed into the pump housing. If there is difficulty priming the pump using this method, use a wet vac to assist in drawing the fluid from the tank into the pump housing.

Note: If the pump has failed to prime turn the chiller off and contact Lytron’s Service Department - 781-933-7300.

CONNECTING POWER (FOR UNITS WITHOUT HEATER OPTION)

⚠ WARNING In order to avoid an electrical potential at the chiller frame due to insulation failure, a proper ground connection to the system must be provided. Failure to do so could result in damage to the equipment, personal injury, and/or death.

Connect a 3-conductor SJT type power cord with an IEC 320/C19 receptacle to the inlet power to the module on the rear of the unit and to an appropriate AC power source. All chillers should use a 12-gauge power cord.

Startup Procedure

1. Turn "ON" the circuit breaker on the rear of the unit. The controller will go through a diagnostic test. Turn on the chiller unit using the top left key located on the Keypad Display panel. The controller displays "OFF" for 8 seconds. The delay prevents rapid cycling of the compressor using the "ON" and "OFF" switch. If your chiller is equipped with control package 2 or 3 the fault shut off may prevent the chiller from starting up. If the chiller displays an alarm after pushing the "ON" button disable the fault shutoff on the customer menu and restart the chiller.
2. Adjust the temperature set point using the controls on the keypad display as follows:
 - Press the "SET" key once to display the current coolant temperature set point.
 - Press the "UP" or "DOWN" arrow key until the desired coolant temperature set point appears on the LED display.
 - Press the "SET" key again to accept the set point and return to normal operation.
3. Operate the chiller for a short time and then check the coolant level in the reservoir. If the level drops, add more coolant.
4. Check all fittings and hoses for fluid leaks. If a leak exists turn chiller off, disconnect power and take necessary action to repair the leak.

Please Note:

During initial start up the temperature display may occasionally appear to be dim. This is a normal occurrence and does not indicate that there is problem with the chiller. After 10 seconds the display will brighten to its normal level.

CHILLER OPERATION

The following sections explain how to perform other operations with the chiller’s controller, using the keys and display on the front of the unit. Refer to the Controller Display Panel Functions section in this manual.

In normal operation the display shows the current temperature of the coolant (or the current temperature with an offset applied).

Customer Menu Options

<i>Display Abbreviation</i>	<i>Function</i>
DEGC	English or Metric Units Changes the temperature readings on the display from °C to °F and pressure from Bar to PSI.
CAL	Calibration Offset Adjusts the reading on the display by the offset that you enter, from -4°C to 4°C (-7°F to 7°F).
Ar	Auto Restart When enabled this allows the chiller to start automatically in the event of a power failure.
Ot	Over temperature Fault Indication (option) Indicator illuminates when the coolant temperature exceeds the over-temperature set point. The over-temperature set point should be at least 3°C (6°F) above the coolant set point to prevent nuisance alarms.
Lt	Low-temperature Fault Indication (option) Indicator illuminates when the coolant temperature falls below the low-temperature set point. The low-temperature set point should be at least 3°C (6°F) below the coolant set point to prevent nuisance alarms.
AL	Audible alarm (option) When this is enabled, an audible alarm sounds when any fault occurs.
FS	*Fault chiller shutoff (option) When enabled, this turns off the chiller when any fault occurs.
rS	Remote Start (option) Allows the chiller to be started and stopped with a dry contact.
bAr	Pressure Units (option) Allows the chiller to display the pressure in units of bar or psi. When bar is “ON” pressure is displayed in units of bar, in the format X.XX b. When bar is off, the pressure will be shown in psi, in the format XX p.

*Low flow shutoff cannot be disabled.

AL—Audible Alarm (option)

1. To enter the menu, press and hold both the “UP” and “DOWN” arrow keys for 3 seconds.
2. Use the “SET” key to scroll to “AL.”
3. The display toggles between “AL” and its current setting.
4. Use “UP” or “DOWN” arrow key to toggle between “ON” and “OFF.”
5. Press, “SET” to accept the setting on the display and continue to the next feature.

Ar - Auto Restart Feature (standard)

If auto restart is enabled (ON):

If the chiller is running and the power is interrupted due to power outage, tripped circuit breaker, etc., the chiller will automatically start when the power is restored.

If auto restart is enabled (OFF):

If the chiller is running and the power is interrupted due to power outage, tripped circuit breaker, etc., the chiller will stay off when the power is restored. Push “ON” to restart the chiller.

To activate the auto restart feature:

1. Enter the customer menu by holding both the “UP” and “DOWN” arrow keys for 3 seconds.
2. Use the “SET” key to scroll to “Ar.”
3. The display toggles between “Ar” and its current setting.
4. Use “UP” or “DOWN” arrow key to toggle between “ON” and “OFF.”
5. Press, “SET” to accept the setting on the display and continue to the next feature.

CAL - Calibration offset (standard)

1. To enter the menu, press and hold both the “UP” and “DOWN” arrow keys for 3 seconds and release.
2. Use the SET key to scroll to “CAL.”
3. The display toggles between “CAL” and current offset setting.
4. Use “UP” or “DOWN” arrows to change the calibration offset, which must be between -4°C and +4°C. If you do not want to use an offset set it to zero (0).
5. Press, “SET” to accept the setting on the display and exit the menu.

DEGC - Temperature scale (standard)

1. To enter the menu, press and hold both the “UP” and “DOWN” arrow keys for 3 seconds and release.
2. The first option to change will be “DEGC.”
3. The display toggles between “DEGC” and current setting. Use “UP” or “DOWN” arrows to turn the degree Celsius display on and off. This will automatically change the pressure scale to psi or to bar.
4. Press, “SET” to accept the setting on the display and exit the menu.

FS—Fault Chiller Shutoff (option)

1. To enter the menu, press and hold both the “UP” and “DOWN” arrow keys for 3 seconds.
2. Use the “SET” key to scroll to “FS.”
3. The display toggles between “FS” and its current setting.
4. Use “UP” or “DOWN” arrow key to toggle between “ON” and “OFF.”
5. Press, “SET” to accept the setting on the display and continue to the next feature.

Lt— Low temperature indication (option)

1. To enter the menu, press and hold both the “UP” and “DOWN” arrow keys for 3 seconds.
2. Use the “SET” key to scroll to “Lt.”
3. The display toggles between “Lt” and current over-temperature set point
4. Use “UP” or “DOWN” arrows to change the low temperature set point, which should be at least 3°C (6°F) below the coolant set point temperature.
5. Press, “SET” to accept the setting on the display and continue to the next feature.

Ot— Over temperature indication (option)

1. To enter the menu, press and hold both the “UP” and “DOWN” arrow keys for 3 seconds and release.
2. Use the “SET” key to scroll to “Ot.”
3. The display toggles between “Ot” and current over temperature set point.
4. Use “UP” or “DOWN” arrows to change the over temperature set point, which should be at least 3°C (6°F) above the coolant set point temperature.
5. Press, “SET” to accept the setting on the display and continue to the next feature.

bAr—Pressure Units

1. To enter the menu, press and hold both the “UP” and “DOWN” arrow keys for 3 seconds.
2. Use the “SET” key to scroll to “bAr.”
3. The display toggles between “bAr” and its current setting.
4. Use “UP” or “DOWN” arrow key to toggle between “ON” and “OFF.” “ON” will display the units in bar and “OFF” will display the units in psi.
5. Press, “SET” to accept the setting on the display and continue to the next feature.

rS—Remote Start Feature (option)

When it is set to off the chiller acts as if it does not have the remote start feature. By setting this feature to “NC” (normally closed or run on closed) the chiller will start when pins 1 and 2 on the six-pin connector on the rear of the chiller are closed. The chiller will shut off when pins 1 and 2 are open. By setting this feature to “NO” (normally open or run on open) the chiller will start when pins 1 and 2 are open. The chiller will shut off when pins 1 and 2 are closed. When the remote start feature is enabled within the user menu and the chiller is in the off state, the chiller cannot be turned on from the front control panel and “rS” will appear on the display. When the remote start feature is enabled within the user menu and the chiller is operating, turning the chiller off from the front panel will result in an “Err 05” on the front display. This can be cleared by pressing the On/Off button again or cycling the remote contact.

1. To enter the menu, press and hold both the “UP” and “DOWN” arrow keys for 3 seconds.
2. Use the “SET” key to scroll to “rS.”
3. The display toggles between “rS” and its current setting.
4. Use “UP” or “DOWN” arrow key to toggle between “OFF”, “nO”, and “nC.”
5. Press, “SET” to accept the setting on the display and continue to the next feature.

SYSTEM MAINTENANCE AND SERVICE

WARNING A qualified service technician must perform all service and maintenance internal to the chiller. Unqualified individuals conducting service on the chiller could result in damage to the equipment, personal injury and/or death.

After your Kodiak Recirculating Chiller is up and running, it takes only a small amount of care and maintenance to keep it running well.

Every installation is unique, and the operating conditions determine how often the equipment should be inspected and maintenance be performed. The following are some guidelines.

Periodic Inspections

Noise Level

Any abnormal sounds or a substantial increase in noise level since the last weekly inspection may indicate the following: impending pump, fan or coolant blockage problem. Investigate the cause and perform the necessary service. Refer to the troubleshooting guide in this manual.

Leakage

If you notice coolant on the floor near the chiller or dripping from the chiller enclosure turn off the chiller. Disconnect the power cord. Find and repair any leaks immediately.

Coolant Level

Any significant drop in the coolant level should be investigated further. If there is no visible system leak, then the loss may be due to equipment leakage elsewhere.

Pump / Motor

Some pumps may require lubrication. If the pump needs lubrication, lubricate annually with 20-30 drops of SAE Oil.

Fan Assembly

No maintenance is required on the fan. Listen for any abnormal sounds.

Condenser Fin

Remove the front grill by sliding it upward, pulling the bottom out and pulling it straight down. For maximum performance the condenser fin should be free of dust and debris. Use a vacuum cleaner or compressed air to remove any debris and keep the fin clean.

Water Filter

With a new system the filter quickly accumulates foreign matter introduced during system setup. This can lead to a decrease in system performance in a short period of time. Inspect the filter cartridge one day after you set up a new system to ensure the filter is clean and the system runs at maximum capacity. After this initial filter inspection, check the filter weekly. For replacement filters contact Lytron's Customer Service at 781-933-7300.

Deionization Package

The cartridge life is a function of the user's application. Check the water resistivity weekly and change the cartridge as required. For replacement filters contact Lytron's Customer Service at 781-933-7300.

Low Level Switch

The level switch protects the pump in the event of accidental fluid loss. Since this switch is "passive" during normal operation, it is advisable to check it every 6 months. Open the tank cover and push down on the switch to see if the low level alarm is activated.

Algae

Lytron recommends the use of an algae inhibitor to prevent growth in the reservoir.

Cleaning the System and Reservoir

To clean the unit follow these steps:

1. Drain the entire unit including the hoses and equipment being cooled.
2. Replace the coolant with clean water.
3. Run the unit with the clean water for 10 minutes.
4. Drain the unit again.
5. Replace all filters.
6. Refill unit with either water or a water and freezing point depressant.

Pump Strainer

All positive displacement pumps have a strainer to protect the vanes inside the pump. For pumps less than 2.5 gpm it is located in the pump housing. For larger PD pumps it is installed in the hose between the pump and the tank. Periodically inspect and clean the pump strainer. If it becomes fouled the flow rate will decrease and the pump may wear prematurely.

The strainer can be cleaned by rinsing it in warm water and brushing it gently. For a detailed procedure in cleaning the pump strainer visit the Maintenance and Troubleshooting section of Lytron's website at www.Lytron.com.

Pumps

As a precaution, the pump must be periodically replaced. This will avoid damaging the unit and the cost associated with excessive downtime. Typical operating life of the pump depends on pump type.

Pump Model	Typical Operating Life
Positive Displacement	7,000 Hours
Centrifugal	28,000 Hours
Turbine	28,000 Hours

Note: Please contact Lytron for pump pricing and delivery.

DRAINING PROCEDURE FOR KODIAK CHILLERS

⚠ WARNING Always disconnect power to chiller when performing service. Failure to do so could result in damage to the equipment, personal injury and/or death.

⚠ CAUTION A container should be available to hold the fluid removed from the chiller. This container should be labeled in accordance with OSHA rules and regulations concerning handling of the fluid being removed from the chiller. Failure to do so could result in personal injury.

⚠ CAUTION Reference the MSDS sheet for the fluid being removed from the chiller for further handling, storage, and disposal instructions. Disposal of fluid removed from the Lytron chiller should be in accordance with all Local and Federal disposal laws. Failure to do so could result in personal injury.

NOTICE Not following this procedure may result in extensive damage to the chiller. It is extremely important to completely drain the chiller when not in use for extended period of time, shipping outside of its current location, during certain repairs, and for scheduled fluid maintenance. Failure to fully drain the system could result in damage of the equipment. Lytron recommends method #1 as the most efficient way to remove fluid from the chiller.

Method #1- Recommended

1. Lytron recommends using a wet/vac to thoroughly remove fluid from the chiller. Remove plastic cap from top of the clean fluid reservoir. Vacuum this tank until it is completely free of any fluid. Keep reservoir cap removed from reservoir until step #5.
2. Using wet/vac, first vacuum the “supply” connection located at the rear of the chiller. After all the fluid has been removed from the supply side, move vacuum to the “return” connection. Vacuum this connection until all fluid has been removed.
3. Remove side panel of chiller to expose the tank drain hose. The drain line is a ½” braided hose terminated with a white PVC cap. The drain line branches off from a tee on the chiller return line.
4. Remove plastic cap plug and place vacuum at the end of the hose. Vacuum any remaining fluid from the system. *(Note: make sure reservoir cap is removed, allowing air to enter system).*
5. Install plastic cap plug to the end of the drain hose. Install side panel. Attach plastic cap to the clean fluid reservoir. Install chiller cover.

Method #2- without access to wet/vac

1. Remove chiller cover. Remove reservoir plastic cap. Keep reservoir cap removed from reservoir until step #4. Remove side panel of chiller to expose the tank drain hose. The drain line is a ½” braided hose terminated with a white PVC cap. The drain line branches off from a tee on the chiller return line.
2. If possible, elevate the chiller approximately 3’ off the ground. This will allow you to drain the system into a 5-gallon bucket.
3. Remove the plastic cap plug from the end of the hose. *(Note: make sure reservoir cap is removed, allowing air to enter system).* Drain the system into a 5-gallon bucket. Because this process is relying on gravity, it may take a few minutes to completely drain the system. If the volume of your system exceeds 5 gallons, have a second bucket nearby.
4. Install plastic cap plug to the end of the drain hose. Install side panel. Attach plastic cap to the clean fluid reservoir. Install chiller cover.

COOLANT MAINTENANCE

Recommended coolant for use in Lytron systems

- Clean water is recommended for most systems. Systems ordered with the deionized plumbing package require that deionized water be used. Use of deionized water in systems with brass components may cause premature failure of the system.
- If the set point temperature is below 50°F/10°C, Ethylene or Propylene Glycol should be added to the water with a mix ratio of 30% Ethylene or Propylene Glycol to 70% water.
- Do not use automotive antifreeze as the rust inhibitors may cause premature failure of the pump seals.
- Avoid using water with a high mineral content.
- If the chiller is exposed to sunlight, add an algaecide to control organic growth in the coolant. A mixture of 30% Ethylene or Propylene Glycol can also be used to control algae growth.

Checking coolant level

- There is a coolant level site tube on the front of the unit. Coolant should be added as soon as this indicator approaches the half-full mark.
- Reducing the coolant volume may reduce the chillers cooling capacity.
- Inspect coolant level weekly or whenever the chiller is powered on.

Flush & replace coolant periodically



In order to avoid electric shock, be sure to wipe up all fluid spills in the unit before applying electrical power. Failure to do so could result in damage to the equipment, personal injury and/or death.

- Depending on the environmental conditions, the coolant should be flushed and replaced as necessary, depending on the amount of particulate matter that has been found in the system during planned maintenance inspections.
- If the pump strainer and coolant is found to have little or no contamination after the first inspection, replacing the coolant and cleaning the strainer can be done less frequently.
- The pump strainer may be located in one of two places. Refer to the strainer cleaning procedures under System Maintenance and Service.
- When the strainer is cleaned or replaced, the electrical power must be disconnected and the system drained of all coolant.

ERROR CODES

There are a few different error codes that can occur during the operation of the chiller. These error codes are displayed on the front keypad of the system. See below for an explanation of each error code.

Err 01 – Controller Initialization Error

This error code signifies an error in the controller software initialization during power up. Contact the Lytron Service Department to resolve this type of error.

Err 02 – RTD Error

This error codes means that the resistance temperature device (RTD) is disconnected or damaged. The controller will display error 02 when the resistance of the RTD is outside of the expected range. A cut wire, a short to the RTD, and an internal malfunction in the RTD, can cause this or if the wires are disconnected. Contact the Lytron Service Department for a replacement part number.

Err 03 – Controller Operational Error

This error code signifies an error in the controller software while the chiller is running. Contact the Lytron Service Department to resolve this type of error.

Err 04 – Low Flow Error

This error code signifies a low flow condition exists. The low flow light, the alarm light and the audible alarm will all sound when an error 04 occurs. The controller will also shutdown the pump, compressor, and fan. See the trouble shooting section for suggestions on how to clear this alarm code.

Err 05 – Remote Start

This error code signifies that chiller has been turned off from the front panel while the remote start feature is enabled within the user menu. This can be cleared by pressing the On/Off button again or cycling the remote contact.

Err 07 – Auto Temperature Shut Down

This error code signifies that the process fluid temperature is above the highest allowable temperature for this chiller. This feature is design to shut the chiller down when the process fluid temperature reaches 10°C above the highest allowable chiller set point. All standard chillers (including part numbers ending in Mxxx) built after 09/24/07 have this feature enabled. Part numbers ending in Cxxx chillers will have this feature enabled upon request of the customer.

TROUBLE SHOOTING GUIDE

Problem	Possible Cause	Recommended Remedy
Unit does not start or shuts off shortly after starting.	No power to the unit, circuit breaker "off" or tripped.	Make sure the unit is plugged in. Verify power to the unit. Turn circuit breaker to the "ON" (I) position. Turn on the unit with the ON (I) key on the keypad.
	Fault shutoff enabled.	Disable fault shutoff. Start unit. Enable shutoff after it is running, if desired.
	Low flow shut off will cause the chiller to stop after 10 seconds.	Fill external line prior to start up. Pump is not Primed – See Pg. 19.
	Low Voltage.	Have a qualified electrician check the electrical service to the unit.
	Cooling load exceeds cooling capacity.	Reduce the cooling load on the unit.
	Controller set point temperature is too high.	Reset the set point to the proper temperature.
	Condenser coil fouled with dust or debris.	Remove the lower grill and vacuum the coil face clean.
	Unit has tripped the high-pressure cutout (RC030, RC045 and water cooled units only.) (See Pg. 38)	Remove air obstructions from around the unit; manually reset the high-pressure control (Inside rear of unit, this is a blue button on a white box. Press to reset.)
Compressor has tripped its internal overload.	Let the unit cool. The overload will reset itself, normally in 30 minutes or less.	
Excessive noise on startup	Liquid refrigerant in the suction line to the compressor.	This should go away after the system runs for a few minutes.
Excessive Pressure in facility water (water-cooled unit only)	Unit has tripped the high-pressure cutout (RC030, RC045 and water cooled units only.) (See Pg. 38)	Manually reset the high-pressure control inside rear of unit, this is a white plastic button on the box. Press to reset.
Noisy compressor	Low voltage or wrong voltage to unit.	Verify power source; check electrical service.
	Unit stored in cool environment for a long period may have collected liquid refrigerant in the compressor.	This should go away after the system runs for a few minutes.
Noisy pump motor	Pump shaft seal damage	Replace pump.
	Excessive pressure drop.	Use either larger hoses or a shorter line length to reduce the pressure drop to equipment to be cooled.
	Positive displacement pump is worn out.	Replace pump with new one. Contact Lytron Service Department for part number and pricing.
Pump motor overheats	Improper voltage to the system.	Verify and correct the voltage to the chiller.
	Obstruction in pump head.	Shut down unit, clear obstructions and restart unit.
Audible alarm stays on (Control Package II and III only)	Low level in reservoir	Add more fluid to reservoir to full mark.
	Level switch is stuck.	Clean the reservoir and level switch.
	Level switch is damaged.	Replace level switch.

Problem	Possible Cause	Recommended Remedy
	Low temperature alarm is set too close to cooling set point temperature.	Adjust low temperature alarm set point.
	High temperature alarm is set too close to cooling temperature set point.	Adjust high temperate alarm set point.
Low coolant flow	Pump suction strainer is clogged. (Positive displacement pumps only.)	Remove strainer, clean and reassemble.
Low coolant flow	Low coolant level or no coolant in the reservoir.	Check for leaks. Repair any leaks and fill reservoir.
	Water filter dirty or clogged.	Change filter cartridge.
	Pressure relief on the pump is set too low. (Positive displacement and turbine pumps only.)	Adjust the pressure relief to 90 psig. For a high-pressure application (over 90 psig) contact Lytron Applications Engineering.
	Restriction in coolant lines external to the chiller.	Eliminate restrictions in the lines. Open any valves.
	Pump overload has tripped.	Turn unit off. Wait for overload to cool. It will reset on its own in 30 minutes or less.
	Leaks in external piping.	Repair leaks.
	Pump motor shaft is bound.	Replace pump motor.
	Damaged pump.	Replace pump.
Chiller shuts down during operation	Shutoff feature is enabled in the controller set up menu. (Controllers with options II and III)	Find out and correct the fault that is causing the shutoff. Disable shutoff feature (see controller set up).
	Low flow switch tripped.	See Low Coolant Flow
	Auto Temperature alarm has tripped.	Process fluid temperature has reach a temperature higher than the system's design temperature.
Temperature display reads incorrectly	Temperature set point is not set properly.	Verify values in the controller, including offset. Reset as necessary.
	Offset incorrectly set.	Reset temperature offset.
Recirculating pressure is too high	Pressure drop through system is too large.	Reduce line length or increase line diameter.
	Pump internal pressure relief is set too high.	Reset pressure relief to 90 psig.
Temperature display dim at start up.	This is a normal part of the start up process. It does not indicate that there is a problem.	Wait 5 to 10 seconds and the display will brighten to its normal level.

KODIAK SPARE PARTS

Item #	Description	Model# Series		
		RC006/RC009	RC011/RC022	RC030/RC045
		Lytron Part Number		
1	Controller PCB	230-0874-P ¹		
3	Circuit Breaker 115V	230-0593	230-0588	N/A
	Circuit Breaker 230V ²	230-0592		230-0591
4	Pump and Compressor Relay	101903-03		
5	Pressure Transducer, Brass	230-1006		
	Pressure Transducer, Stainless Steel	230-1007		
	Pressure Transducer, Plastic	230-0603		
7	Temperature Sensor (RTD)	250-0072		
8	Tank	340-0020	340-0018	340-0019
9	Low Level Switch	230-0892		
10	Upper Front Panel	340-0012	340-0014	340-0016
11	Keypad	230-0947		
12	Cover	330-1139-06	330-1165-06	330-1172-06
13	Access Panel	330-0880-06		
14	Side Panel	330-1138-06	330-1166-06	330-1173-06
15	Front Grille	340-0013	340-0015	340-0017
16	Casters with lock	531-0026		531-0016
	Casters without lock	531-0027		531-0017
17	Rear Panel	330-1141	330-1167	330-1174
18	Hot Gas Bypass Valve	All of these parts require service by a qualified refrigeration technician. Please contact Lytron if you have any problems with one of these parts.		
19	Solenoid Valve			
20	Heat Exchanger			
21	Capillary Tube			
22	Liquid Line Filter Dryer			
23	Condenser			
24	Compressor			
25	Condenser Fan	Contact Lytron for replacement fan part number.		
26	Flow Switch	250-0136		230-0912

¹ Please include model and serial number when ordering the controller PCB so they may be correctly programmed.

² Chillers with a heater require a different circuit breaker. Contact Lytron's Customer Service at +1-781-933-7300 for additional information.

Item #	Pumps and Motors	(All Models)
		Part Number
6	1.3 gpm Brass Pump Kit	205-0004
	1.8 gpm Brass Pump Kit	205-0005
	2.3 gpm Brass Pump Kit	205-0006
	4.3 gpm Brass Pump Kit	205-0007
	1.3 gpm Stainless Steel Pump Kit	205-0009
	1.8 gpm Stainless Steel Pump Kit	205-0010
	2.3 gpm Stainless Steel Pump Kit	205-0105
	4.3 gpm Stainless Steel Pump Kit	205-0011
2	1/4 Hp 115 V Motor	230-0202
	1/4 Hp 230 V Motor	230-0214
	1/3 Hp 115/230 V Motor	230-0215
	1/2 Hp 115/230 V Motor	230-0203
* 6A ¹	1/20 Hp Centrifugal Pump 115 V	410-0196
	1/20 Hp Centrifugal Pump 230 V	410-0197
	1/4 Hp Centrifugal Pump 115 V	101773-06
	1/4 Hp Centrifugal Pump 230 V	101773-05
	1/2 Hp Turbine Pump 115/230 V	410-0229
	1/6 Hp Turbine Pump 115V "EC"	410-0336
	1/6 Hp Pump 230V "EC"	410-0337

ACCESSORIES FOR THE KODIAK RECIRCULATING CHILLER

Description	Lytron Part Number
5" Water Filters (min order 10)	330-0022
Air Filter RC006/RC009	330-0053
Air Filter RC011/RC022	330-0692
Air Filter RC030/RC045	330-0683
Water Filter Kit	200-0441
External Pressure Relief Kit (0-50 psig)	200-0196
External Pressure Relief Kit (50-100 psig)	200-0080

¹ Item 6A refers to Pump & Motor combination.

FRONT VIEW

(Reference Spare Parts List in this manual)

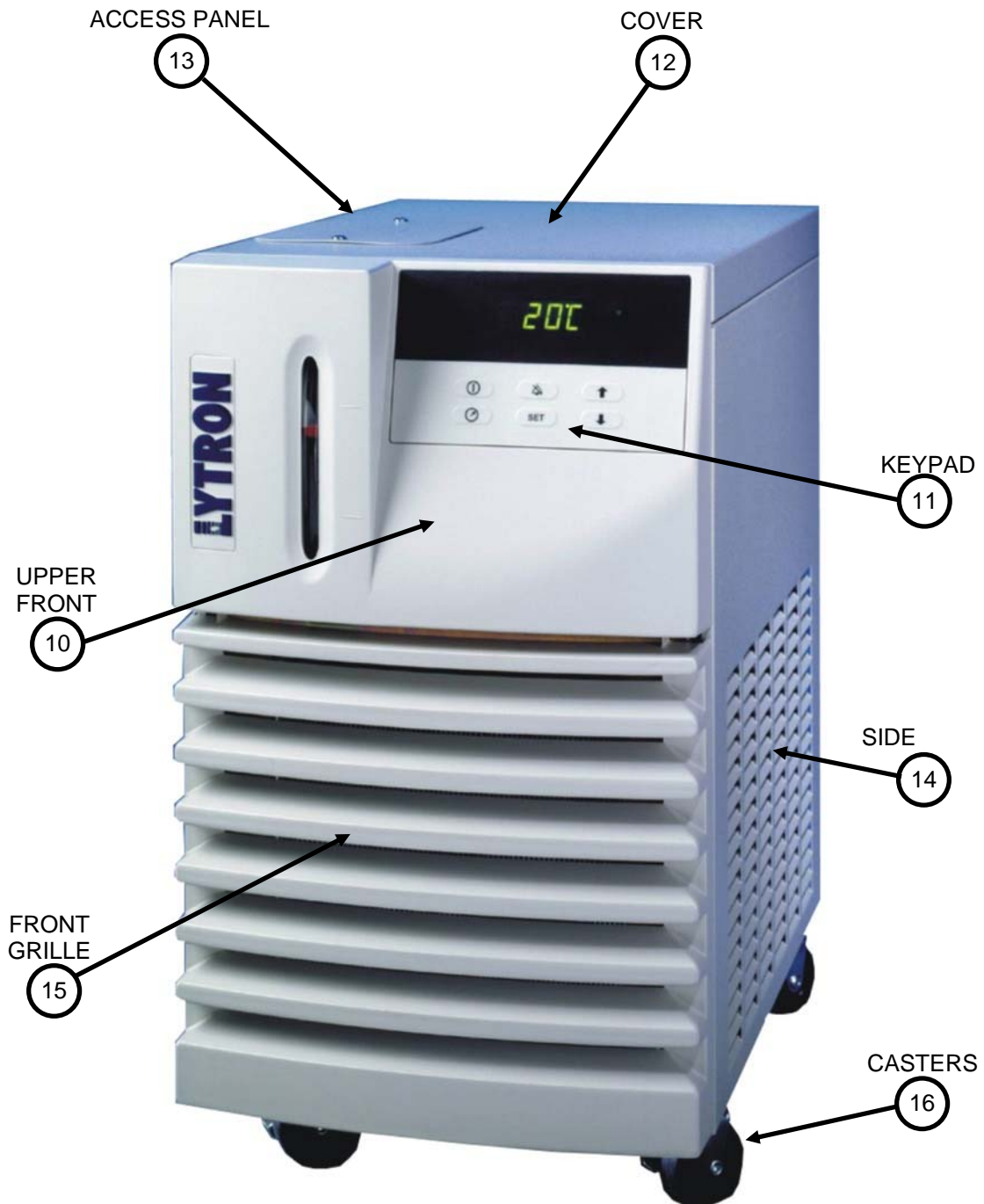

REAR VIEW (WITH PANEL)

(Reference Spare Parts List in this manual)



TOP VIEW

(Reference Spare Parts List in this manual)

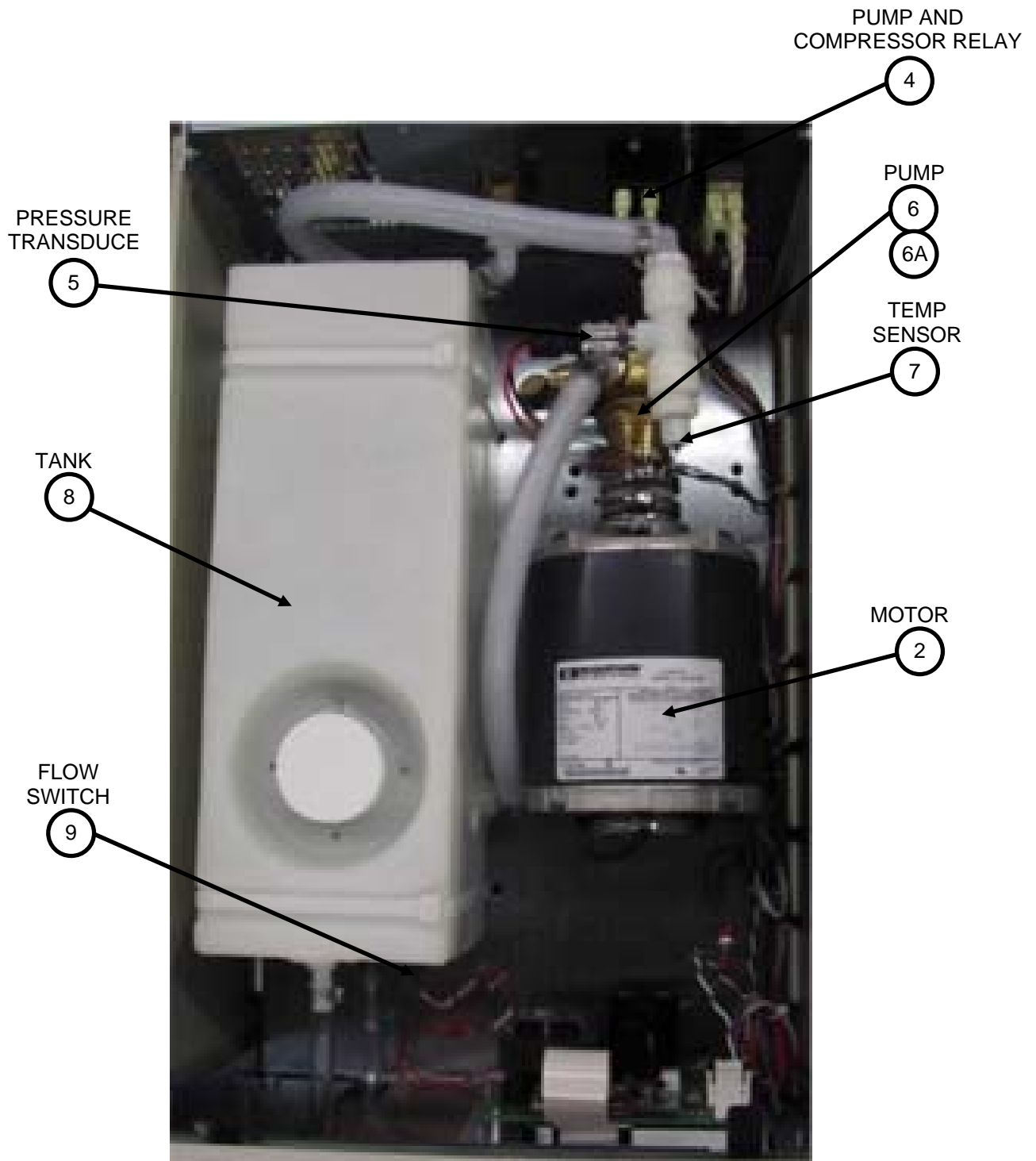

REAR VIEW (OPENED)

(Reference Spare Parts List in this manual)

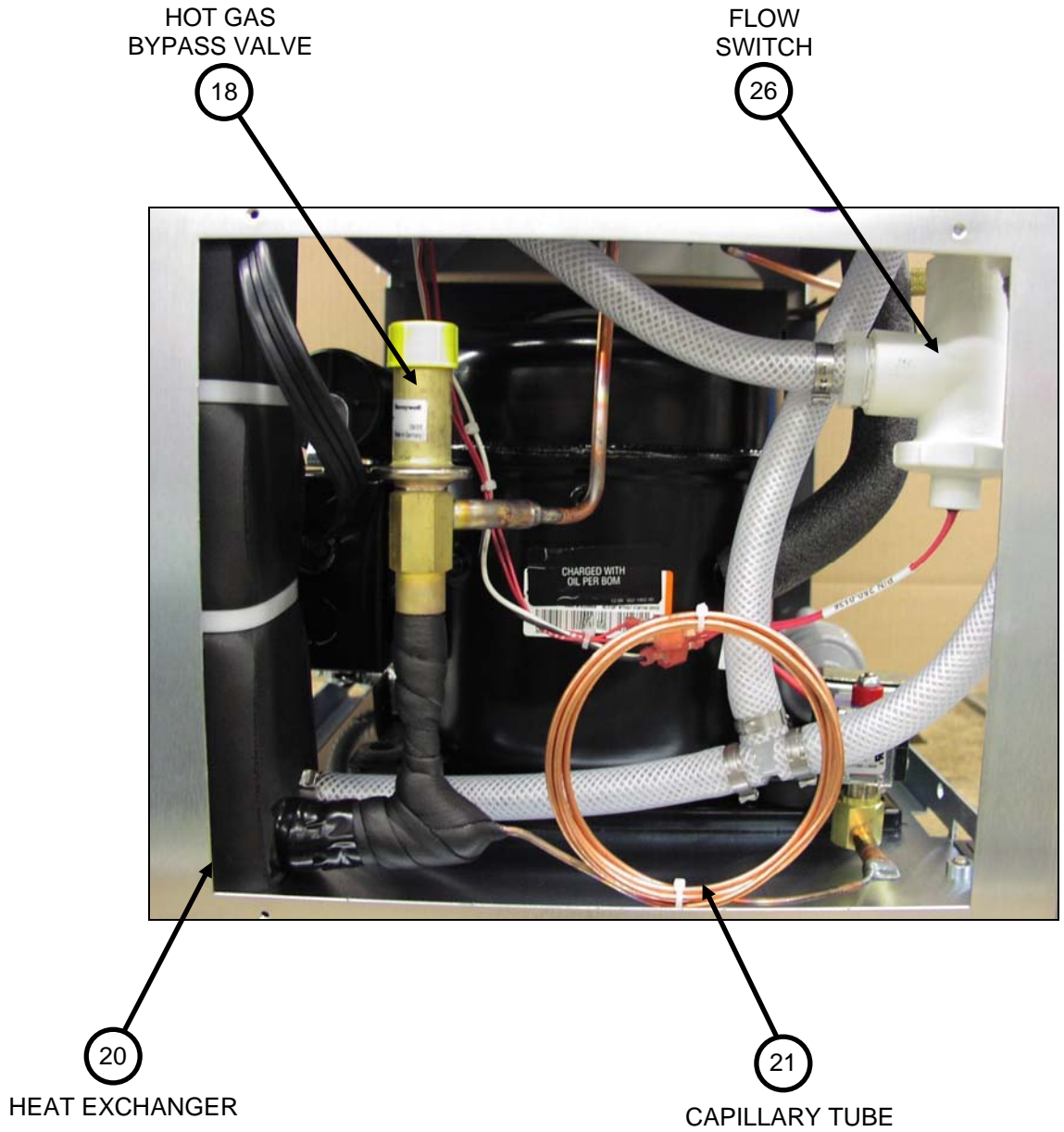

SIDE VIEW

(Reference Spare Parts List in this manual)

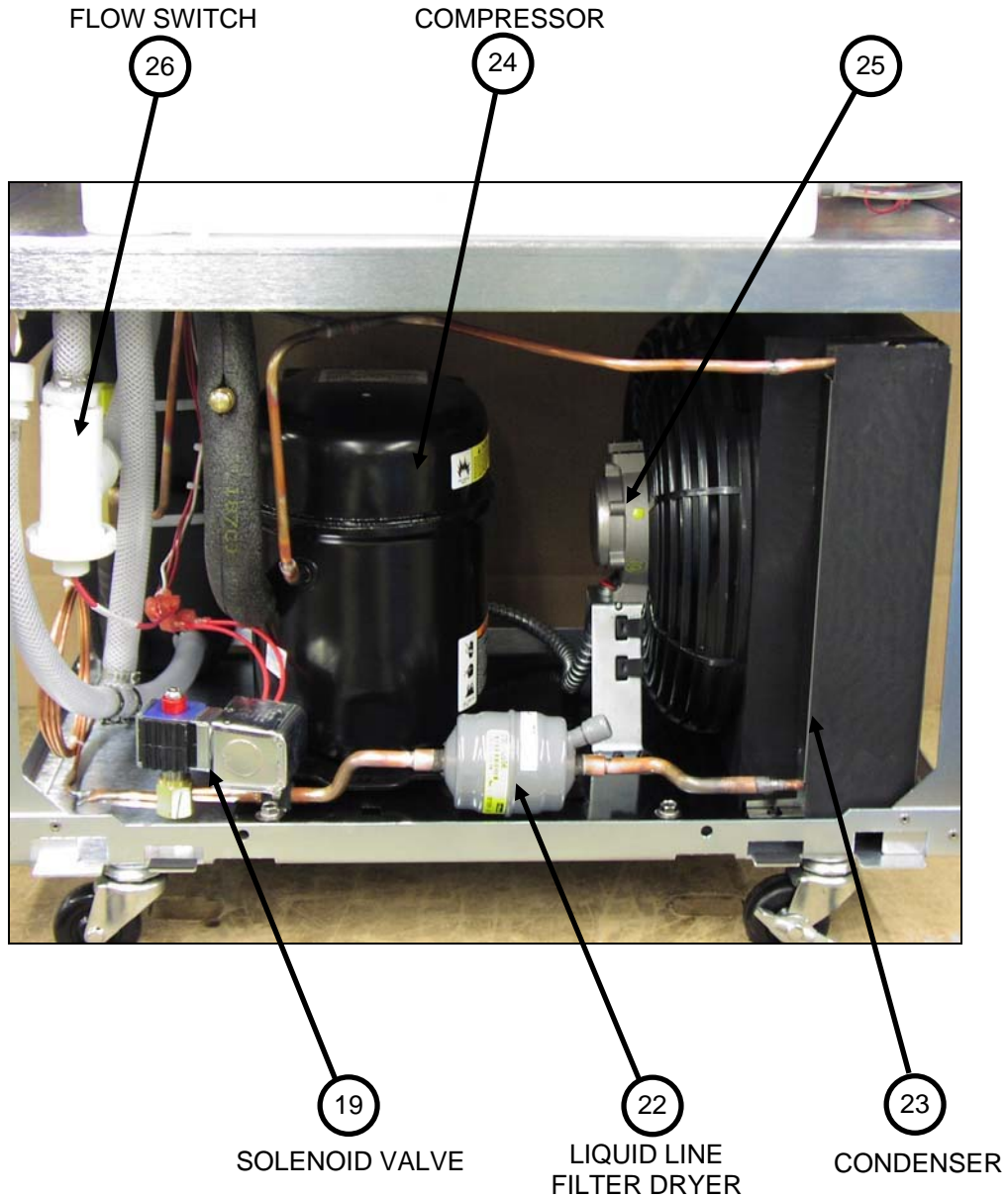

SIDE VIEW (WITH HIGH PRESSURE CUTOUT)

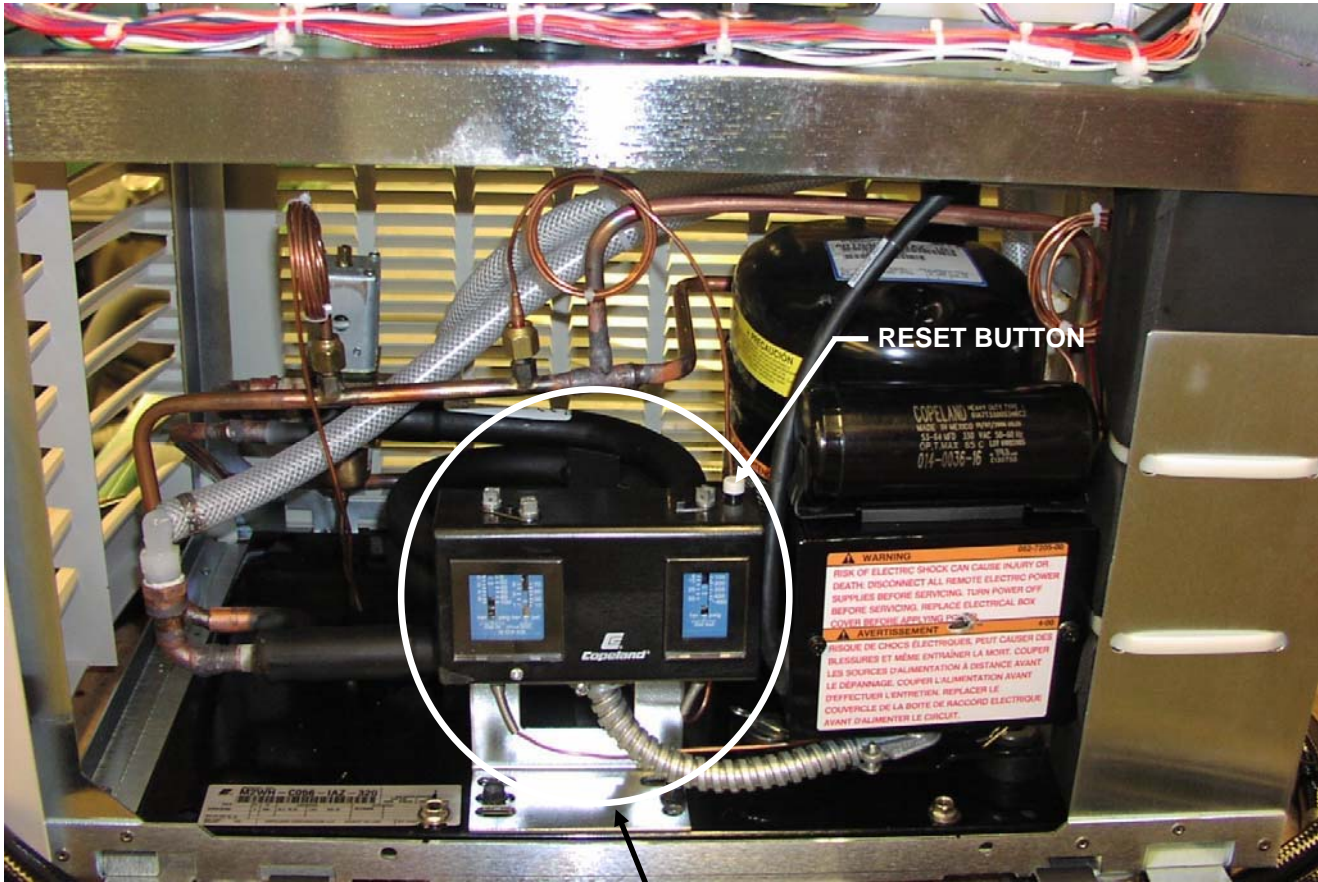

RESET BUTTON

HIGH PRESSURE CUTOUT

CHILLER DIMENSIONS FOR RC006 AND RC009

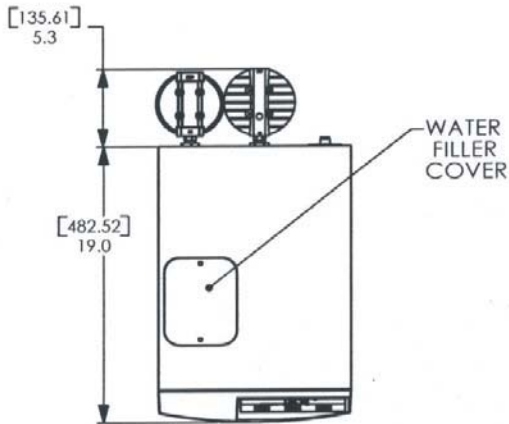

- LEGEND**
- (A) 1/2" FNPT BULKHEAD
 - (B) CIRCUIT BREAKER
 - (C) INLET POWER MODULE (IEC320)
 - (D) CUSTOMER CONTACTS (OPTIONAL)
 - (E) RS232 CONNECTOR (OPTIONAL)
- DIMENSIONS IN [] ARE IN MILLIMETERS

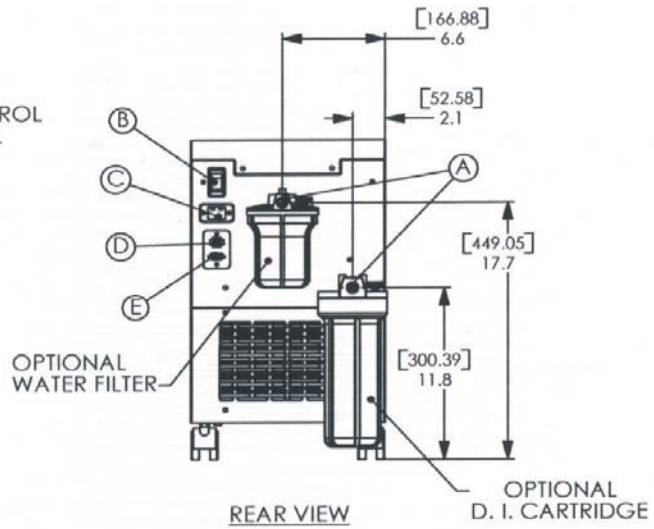
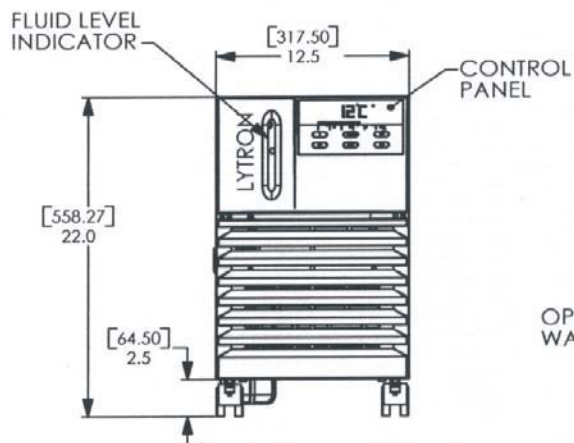

CHILLER DIMENSIONS FOR RC011 AND RC022

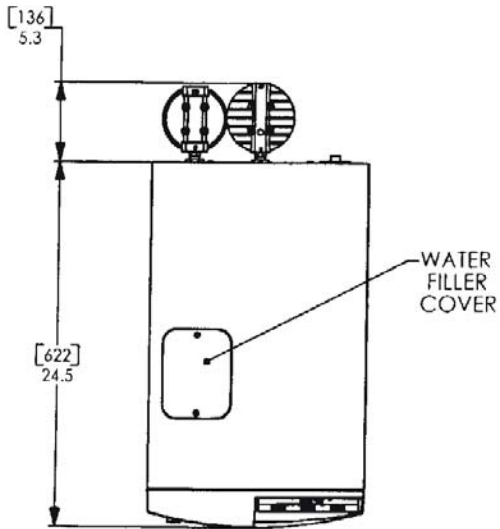

- LEGEND**
- (A) 1/2" FNPT BULKHEAD
 - (B) CIRCUIT BREAKER
 - (C) INLET POWER MODULE (IEC320)
 - (D) CUSTOMER CONTACTS (OPTIONAL)
 - (E) RS232 CONNECTOR (OPTIONAL)

DIMENSIONS IN [] ARE IN MILLIMETERS

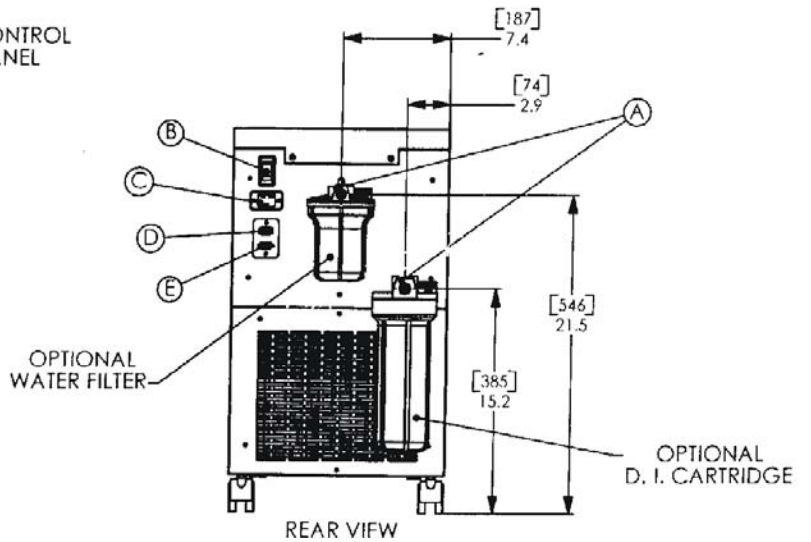
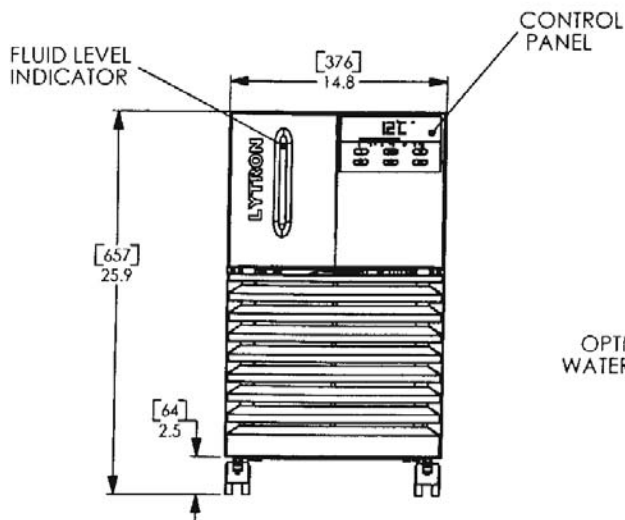

CHILLER DIMENSIONS FOR RC030 AND RC045

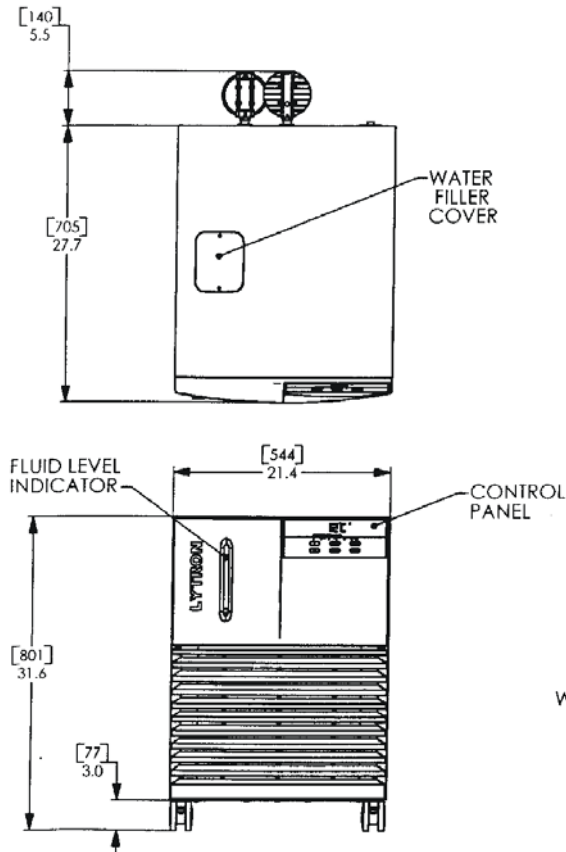

LEGEND

- (A) 1/2" FNPT BULKHEAD
- (B) CIRCUIT BREAKER
- (C) INLET POWER MODULE (IEC320 CONN.)
- (D) CUSTOMER CONTACTS (OPTIONAL)
- (E) RS232 CONNECTOR (OPTIONAL)

DIMENSIONS IN [] ARE IN MILLIMETERS

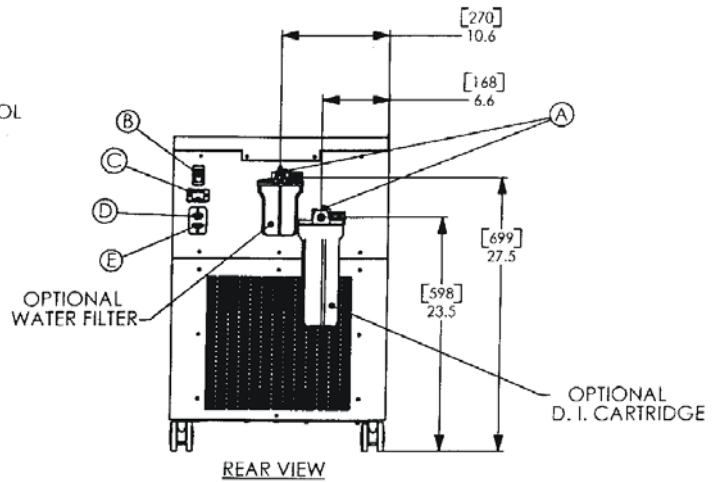

WIRING DIAGRAM

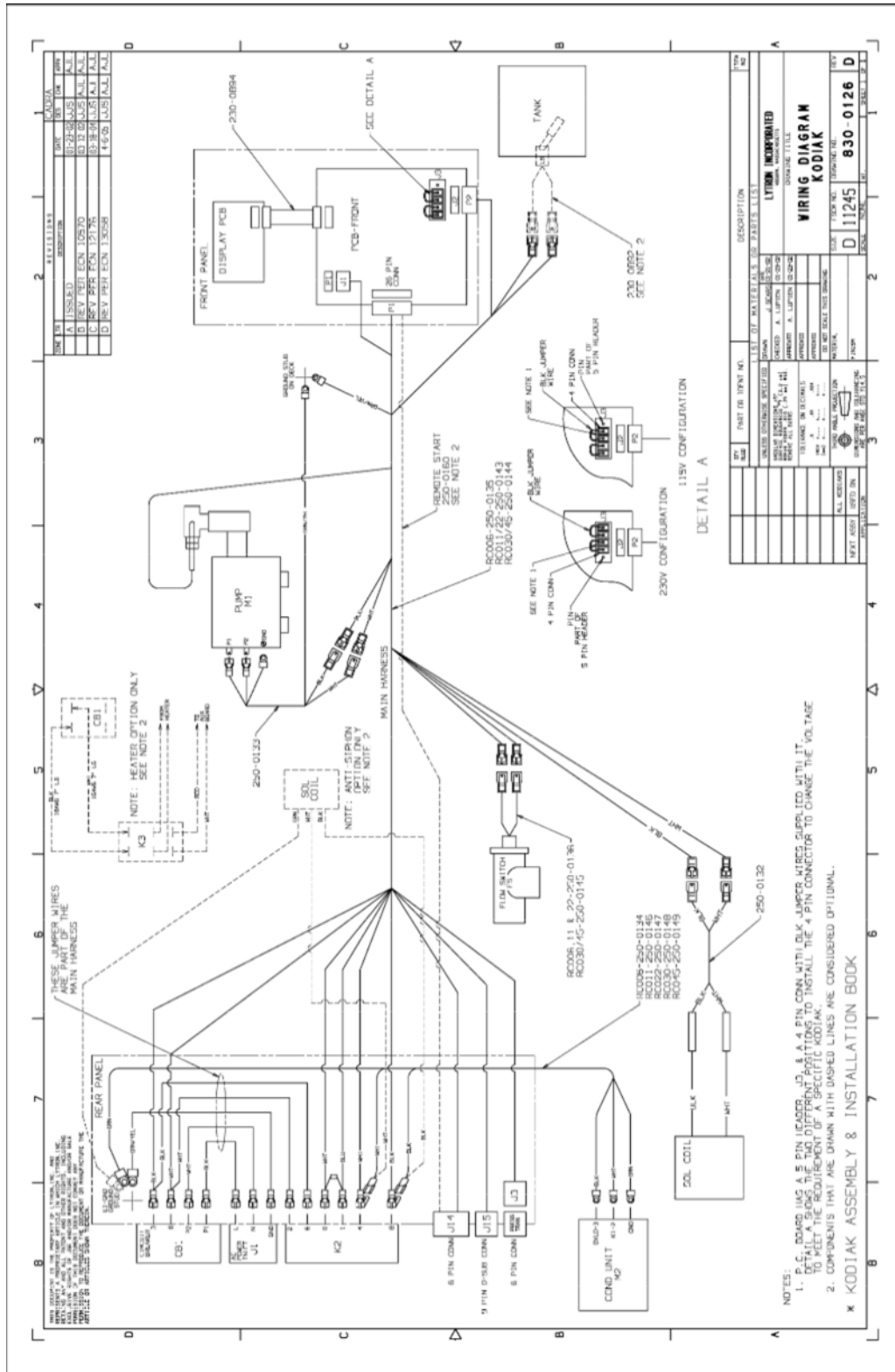

PLUMBING DIAGRAM

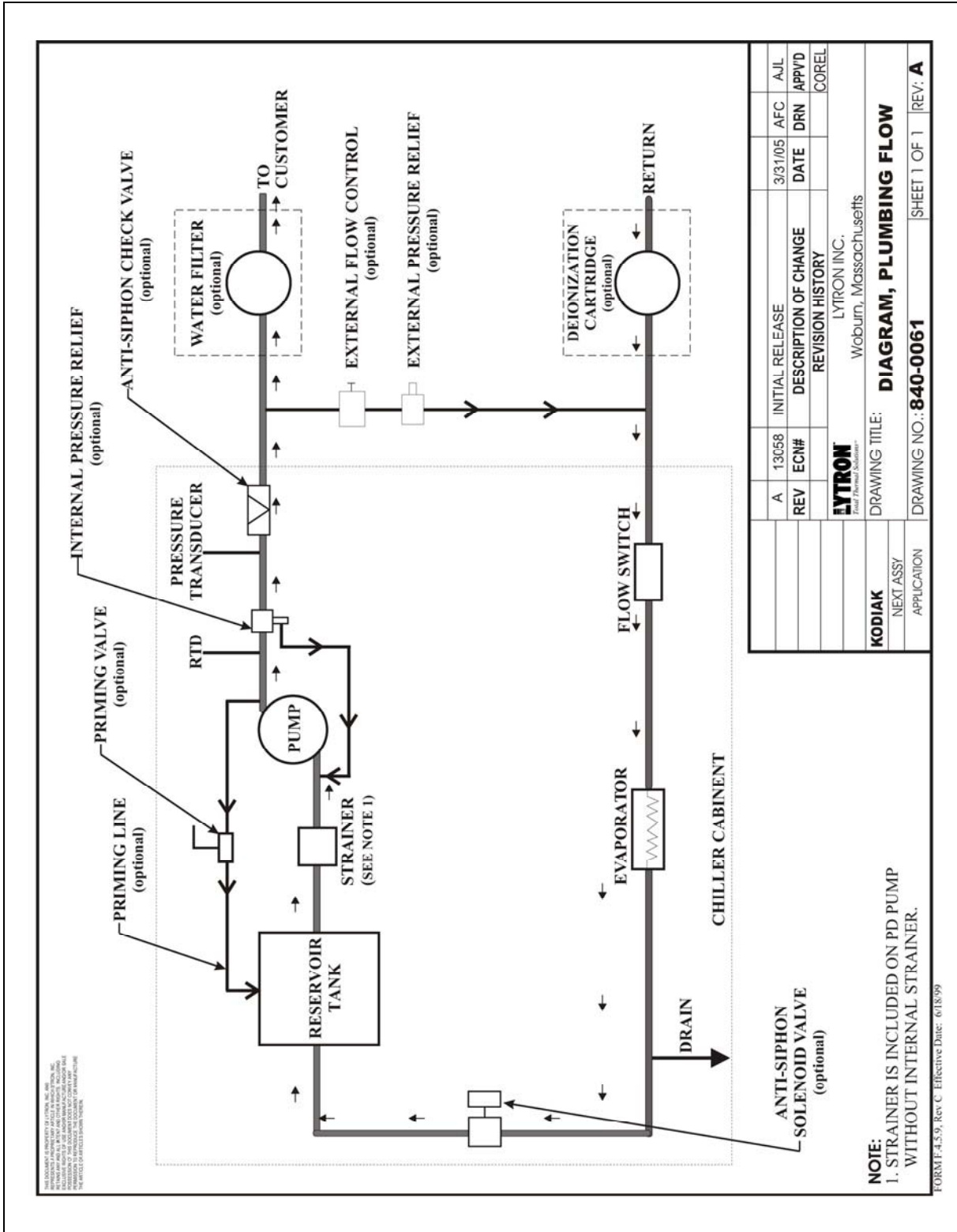

REFRIGERATION DIAGRAM

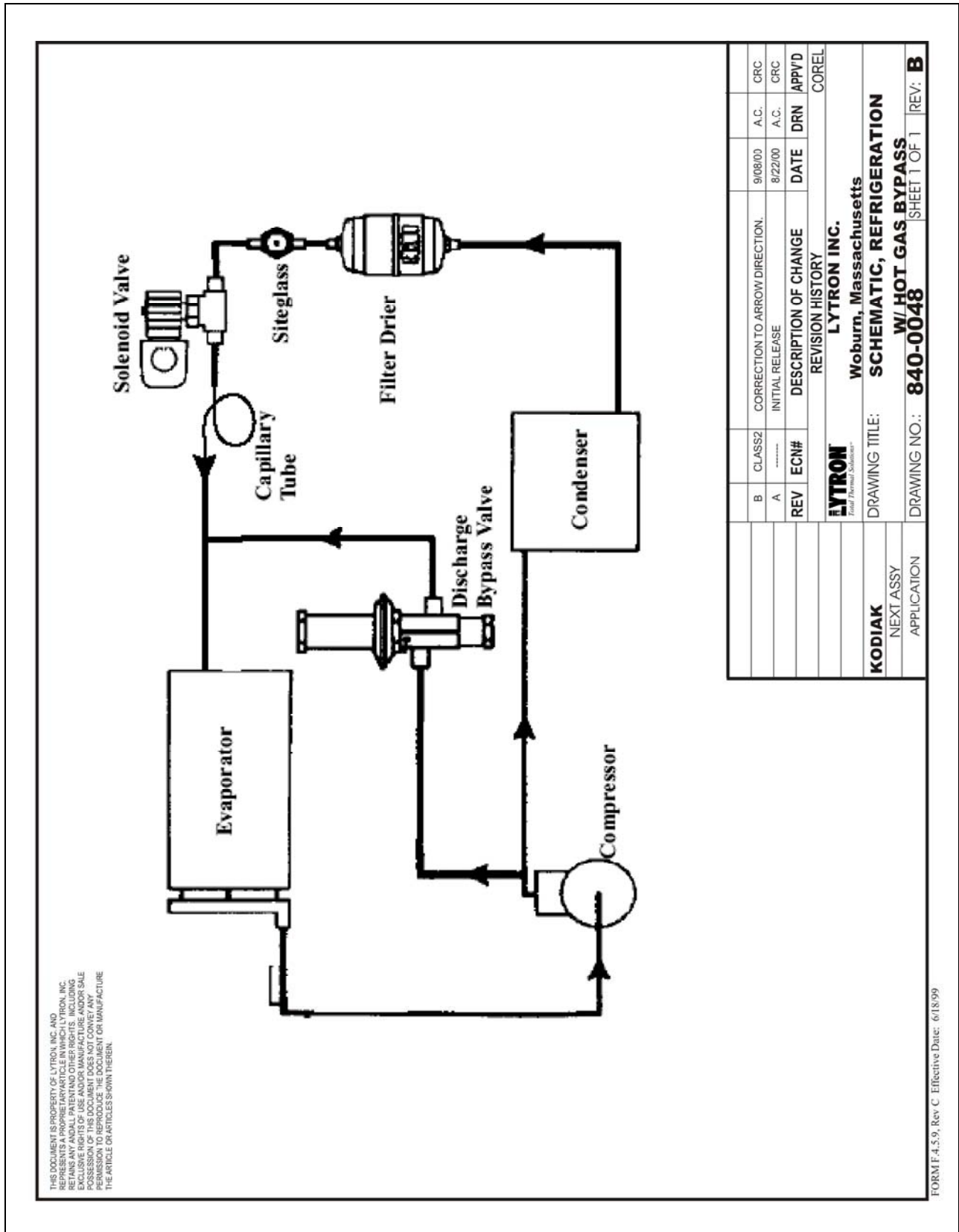

HOST INTERFACE DATA LINK

Control Package 3 only

1.0 Host Interface Data Link

The chiller supports basic host control capability through the Chiller RS-232 port.

1.1 Port Settings

The host port runs at 9600 baud, 8 data bits, 1 stop bit, and no parity.

1.2 Flow Control

The chiller negates the Chiller RTS (output from Chiller) line whenever the Chiller is busy in a non-interruptible process. The Chiller ignores the Host CTS line. No software (Xon/Xoff) flow control is provided. It is the responsibility of the host to issue only a single command for which a response from the Chiller Control is required until the response is received from the Chiller Control. Inter and intra message timeout is defined as 1 second. (Typical response times and character pacing will be baud rate limited.)

1.3 Encoding

All characters are to be ASCII characters. All messages from the host to the control and from the control to the host will have 0x10 (ASCII Line Feed) as a start-of-message delimiter, and 0x0D (ASCII Carriage return) as an end-of-message delimiter. Permitted message characters are in the range of 0x20 through 0x7F (hexadecimal).

1.4 Numeric Representation

Hexadecimal numbers, using ASCII characters '0' – '9' & 'A' – 'F', will represent all numeric values. When the Chiller Control returns multiple variables or parameters they will be white space separated (using ASCII 0x20). The host should recognize and use comma, tab and space as white space characters.

1.5 Units

All temperature values will be communicated in two byte hex values of °Cx100 (.01 C°). Resolution of temperature values is .1 degree. All pressure values will be communicated in integer psi with no offset.

1.6 Commands

1.6.1 The following host Control messages are defined:

1.6.2 Read Chiller Status

This command ('R') will cause the Chiller Control to return a complete status string with the following form:

^JR ControlFlags AlarmFlags PlantTemp SetTemp Pressure ^M

Where: ControlFlags Status in Bit encoded Byte (2 chars). Assignments are:

Bit 7:	(MSB); Machine on:	Lights the temperature display and pressure indicator bar
Bit 6:	Expansion Relay2 on:	Not used by host program
Bit 5:	Expansion Relay1 on:	Not used by host program
Bit 4:	Heater on:	Not used by host program
Bit 3:	Autopilot:	Not used by host program
Bit 2:	Condenser Relay on:	Not used by host program
Bit 1:	Cool Valve On:	Light the Cool Status
Bit 0:	(LSB); Celsius Display on:	Determines the display in Low resolution

Where: Alarm Flags Status in Bit encoded Byte (2 chars). Assignments are:

Bit 7	(MSB) Over Temp:	Over Temperature Alarm is lit
Bit 6	Lo Temp:	Low Temperature Alarm is lit
Bit 5	Low Flow:	Low Flow Alarm is lit
Bit 4	Low Level:	Low Level Alarm is lit
Bit 3	Not used:	Not used
Bit 2	Not used:	Not used
Bit 1	Audible Alarm on:	Alarm transistor (AI toggle)
Bit0	(LSB); Summary Alarm on:	Beeps computer

PlantTemp and SetTemp encoded (2-byte hex (°Cx100))
Pressure encoded is integer value (hex 1-byte)

1.6.3 Read Plant Temperature

This command ('T') will cause the Chiller Control to return the plant temperature in a status string with the following form:

^JT PlantTemp^M

Where: PlantTemp Plant Temperature Value (2-byte hex (°Cx100))

^J ^MAscii Linefeed and Carriage Return

1.6.4 Read Set Point Temperature

This command ('S') will cause the Chiller Control to return the current setpoint temperature in a status string with the following form:

^JS SetTemp^M

Where: SetTemp Setpoint Temperature Value (2-byte hex (°Cx100))

^J ^MAscii Linefeed and Carriage Return

1.6.5 Read User Menu Configuration

This command ('U') will cause the Chiller Control to return the current User Menu configuration information in a status string with the following form:

^JU UserControlFlags OverTempAlmLmt LowTempAlmLmt OffsetCal^M

Where: UserControlFlags Status in Bit encoded Byte (2 chars). Audible Alarm Enable & Fault Chiller Shutoff are encoded in this byte as follows:

Bit 7:	(MSB):Chiller PowerOn:	Host signal to turn on
Bit 6:	Chiller PowerOff:	Host signal to turn off
Bit 5:	Chiller F/C:	Host Signal to toggle F/C
Bit 4:	Fault Chiller Shut Off:	Fault chiller shutoff is enabled, lights host window
Bit 3:	Audible Alarm Enable:	Audible Alarm is enabled
Bit 2:	Not used	
Bit 1:	Remote Start NC:	Remote start contact closure to run, else Off
Bit 0:	(LSB); Remote Start NO:	Remote start contact open to run, else Off

OverTempAlmLmt: High Temp Limit Setpoint (2-byte hex (°Cx100))

LowTempAlmLmt: Low Temp Limit Setpoint (2-byte hex (°Cx100))

OffsetCal Plant Temp Offset (2-byte hex (°Cx100))

^J ^MAscii Linefeed and Carriage Return

1.6.6 Set Chiller Control Plant Setpoint Temperature

This command ('P') from the host will set the Chiller Control Temperature Setpoint. The Host command is of the form:

^JP SetTemp^M

Where: SetTempSetpoint Temperature Value (2-byte hex (°Cx100)

^J ^MASCII Linefeed and Carriage Return

1.6.7 Set Optional Over-temperature Limit

This command ('X') from the host will set the Chiller Optional Over-temperature Limit. Note that it is the host's responsibility to determine if this option is active. The Host command is of the form:

^JX OverTempAlmLmt ^M

Where: OverTempAlmLmtHigh Temp Limit Setpoint (2-byte hex (°Cx100)

^J ^MASCII Linefeed and Carriage Return

1.6.8 Set Low Temperature Alarm Limit

This command ('Y') from the host will set the Chiller Optional Low-temperature Limit. Note that it is the host's responsibility to determine if this option is active. The Host command is of the form:

^JY LowTempAlmLmt ^M

Where: LowTempAlmLmtLow Temp Limit Setpoint (2-byte hex (°Cx100)

^J ^MASCII Linefeed and Carriage Return

1.6.9 Set Offset Calibration

This command ('Z') from the host will set the Chiller Plant Temperature Offset Calibration. The Host command is of the form:

^JZ OffsetCal ^M

Where: OffsetCalOffset Calibration (2-byte hex (°Cx100)

^J ^MASCII Linefeed and Carriage Return

1.6.10 Set User Control Flags

This command ('W') from the host will set the Chiller User Control Flags. As noted in the bit descriptions above, the host may use the Power-On and Power-off bits to force the Chiller On/Off. The Host command is of the form:

^JW UserControlFlags ^M

Where: UserControlFlags in Bit encoded Byte (2 chars)

Bit 7: (MSB); Chiller On

Bit 6: Chiller Off

Bit 5: F/C degree display toggle (not active in .1 display mode)

Bit 4: Fault Chiller shutoff enable

Bit 3: Audible alarm enable

Bit 2: Not used

Bit 1: Auto Start with NC

Bit 0: (LSB); Auto Start with NO

^J ^MASCII Linefeed and Carriage Return

LYTRON COOLING SYSTEMS SERVICE POLICY

Lytron's cooling systems are the product of over 40 years of thermal engineering and manufacturing experience. We designed them to provide superior reliability, easy maintenance, and worry-free operation. However, occasionally a system may need repair. To ensure your process is back up and running quickly, Lytron has implemented the following cooling system service policy.

Lytron's Standard Warranty

Lytron's warranty is set forth at the end of the cooling system manual sent with each product.

Diagnostic Consultation:

At no cost, Lytron will attempt to diagnose the problem over the phone. Our service department can be reached by calling +1-781-933-7305 and following the menu. Service technicians are available 24 hours/7 days for consultation. Lytron strongly encourages customers to take advantage of this service before returning a cooling system to Lytron for evaluation. Often a problem with a system can be fixed quickly in-house or is an application problem. By working with Lytron's service department to troubleshoot a cooling system, you do not have the downtime and expense associated with returning the system to our factory.

Phone diagnosis can be difficult and may actually be a trial and error process. Lytron will not assume any liability for misdiagnosis when diagnosing over the phone.

Warranty and Non-warranty Returns:

To return a cooling system, a Lytron Return Material Authorization (RMA) number must be obtained from Lytron's service department, which can be reached by calling +1-781-933-7305 and following the menu. Prior to calling, the system part number, serial number, and a detailed description of the problem must be recorded, as this information is required to assign an RMA number. A Purchase Order, (PO), is also required for the evaluation and repair charges if Lytron determines the system is not defective as defined by the warranty (see below for more details). The RMA number should be indicated on the outside packaging of the returned unit. Systems must be returned clean, dry, and free from chemicals to Lytron's factory, shipping costs prepaid. Lytron is not responsible for any damage incurred in the return shipment.

Lytron ordinarily will evaluate the unit within 2 or 3 business days of receipt. Lytron will use reasonable effort to repair the unit promptly, in most cases within one week of receiving all the required parts.

If upon examination Lytron determines the system is not defective as defined by the warranty, an evaluation fee of \$375 to \$595, depending upon the system type will be charged. The evaluation fee will be charged regardless of disposition (i.e.: scrap).

In order to expedite the repair process for both warranty and non-warranty repair returns, a PO is required with recommended limits that will be determined when calling for the RMA. The amount suggested will cover the evaluation fee and most repair charges for non-warranty repairs. Lytron will proceed with the repair unless the total charges (evaluation and repair) exceed the amount of the PO. If this is the case, Lytron will provide a quote before proceeding with the repair. Repairs determined to be covered under warranty will not have any charges posted against the PO.

Debit memos should not be issued for warranty and non-warranty repairs unless the unit is returned as a result of an out-of-box (new) failure.

Lytron will warranty the repair for one year from the repair date under the terms of our standard warranty or for the balance of the original warranty, whichever is longer.

Return Shipments:

Lytron's warranty covers payment for standard, ground return shipment of warranted repairs. The incremental difference for expedited return shipments, if requested, are the responsibility of the customer. After non-warranty repair, Lytron will ship the system back using the customer's preferred shipping method.

Field Service/Installation Charges

Where available, Lytron can arrange field service for cooling system installation or repair. Under no circumstances does Lytron's warranty cover on-site service. All on-site service must be arranged through Lytron's service department. The charges for this service are as follows:

\$250 administrative fee

Plus the following:

- \$100/hr for on-site services provided*
- Any related travel charges
- Parts not covered under warranty.

* The hourly labor rate may vary depending upon city. Contact Lytron's service department for current rates in effect at the time.

All requests for On-Site Services require a PO or credit card in the amount of \$800 before services will be scheduled.

When using Lytron-arranged, on-site service, Lytron warranties the replacement parts and repair labor for 90 days from the repair date under the terms of our standard warranty or for the balance of the original warranty, whichever is longer. If non-authorized labor repairs the system or installs replacement parts, Lytron does not warranty the parts or work and this action potentially voids any remaining warranty.

Lytron is expanding its worldwide service presence. Please contact the Service Department for the latest areas where on site service is available.

Replacement Parts:

Replacement parts can be ordered using a credit card or purchase order. Parts being returned from systems under warranty should be returned using a Lytron issued RMA number. If the parts are found to be defective and the claim is within the warranty period, credit will be issued for the price of the parts and one-way ground shipping charges. If the parts are not defective or indicate end user damage, no credit will be issued. Lytron will not cover the incremental cost of air shipment of replacement parts, regardless of warranty status.

In-stock parts normally will be shipped the next business day; non-stocked parts will be shipped as quickly as reasonably possible.

This policy is subject to change. Please check with Lytron's service department for the current policy.

LYTRON KODIAK RECIRCULATING CHILLER STANDARD WARRANTY

Lytron agrees that the apparatus manufactured by it will be free from defects in materials and workmanship for the warranty period under normal use and service and when properly installed. The warranty period for recirculating chillers is two years from date of shipment of such apparatus to the original purchaser, maintenance items excluded, and one year from date of shipment of such apparatus to the original purchaser for all other products Lytron sells. Lytron's obligation under this agreement is limited solely to repair or replacement, at its option, at its factories, of any part or parts thereof, returned to Lytron with transportation charges prepaid, which examination shall disclose to Lytron's satisfaction to have been defective. THE FOREGOING EXPRESS WARRANTY IS IN LIEU OF ALL OTHER WARRANTIES, EXPRESSED OR IMPLIED, INCLUDING BUT NOT LIMITED TO WARRANTIES OF MERCHANTABILITY AND FITNESS FOR A PARTICULAR PURPOSE. LYTRON'S OBLIGATION UNDER THIS WARRANTY IS STRICTLY AND EXCLUSIVELY LIMITED TO THE REPAIR OR REPLACEMENT OF DEFECTIVE COMPONENT PARTS AND LYTRON DOES NOT ASSUME OR AUTHORIZE ANYONE TO ASSUME FOR IT ANY OTHER OBLIGATION. LYTRON ASSUMES NO RESPONSIBILITY FOR INCIDENTAL, CONSEQUENTIAL, OR OTHER DAMAGES INCLUDING, BUT NOT LIMITED TO LOSS OR DAMAGE TO PROPERTY, LOSS OF PROFITS OR REVENUE, LOSS OF THE UNIT, LOSS OF TIME, OR INCONVENIENCE. Lytron's liability does not include any labor charges for replacement of parts, adjustments, repairs, or any other work done outside its factories and its liability does not include any resulting damage to persons, property, equipment, goods or merchandise arising out of any defect in or failure of its apparatus. Lytron's obligation to repair or replace shall not apply to any apparatus which shall have been repaired or altered outside of its factory in any way, or which has been subject to negligence, to misuse, or to pressures in excess of stated limits. On parts not of Lytron's manufacture, such as motors, controls, etc., Lytron extends only those warranties given to Lytron, Inc. to the extent Lytron can do so. Lytron's agreement hereunder runs only to the immediate purchaser from Lytron, Inc. and does not extend, expressly or by implication, to any other person.

Form F4.3.18 Rev E June 6, 2003

DECLARATION OF CONFORMITY



DECLARATION OF CONFORMITY

Product Description: Kodiak Recirculating Chiller System
Model Number: RC006, RC009, RC011, RC022, RC030, and RC045
G03, H03, and J03 Series

We, Lytron Incorporated, 55 Dragon Court, Woburn, Massachusetts, 01801, USA, declare that the product described above is in conformity with 2006/95/EC Low voltage Directive and 2004/108/EC EU EMC Directive using the relevant sections of the following standards and other normative documents:

EN 61010-1: 2nd Edition

Safety Requirements for Electrical Equipment for Measurement, Control, and Laboratory Use. Part 1 General Requirements; Corrigendum 1:05/2002; Corrigendum 2:04/2003

EN 61326-1

Electrical Equipment for Measurement, Control and Laboratory Use EMC Requirements. Part 1 General Requirements - IEC 61326-1:2005;1997.

This product has been qualified in accordance with the requirements established in Low Voltage Directive 2006/95/EC and Electromagnetic Compatibility Directive 2004/108/EC and is manufactured in compliance with Lytron's registered BS EN ISO 9001:2008 Quality System.

Authorized Lytron Representative

Date

55 Dragon Court / Woburn, MA 01801 USA / Tel 781-933-7300 / Fax 781-935-4529 / www.Lytron.com



F4.3.42 Rev A 07/06/2010